

CONTENT (MLCC)

E STANDARD NUMBER..... 3

STRUCTURE 4

ORDERING CODE 4

MIDDLE-HIGH VOLTAGE (100V~3KV)..... 5

NP0 Series 6

X8G Series 15

X5R Series 16

X7R Series 17

X7S Series..... 25

X7T Series..... 26

X6S Series..... 26

TEST SPEC. 27

PACKAGE 31

OTHERS 35

E Standard Number

E3	1.0						2.2						4.7											
E6	1.0			1.5			2.2			3.3			4.7			6.8								
E12	1.0	1.2	1.5	1.8	2.2	2.7	3.3	3.9	4.7	5.6	6.8	8.2												
E24	1.0	1.1	1.2	1.3	1.5	1.6	1.8	2.0	2.2	2.4	2.7	3.0	3.3	3.6	3.9	4.3	4.7	5.1	5.6	6.2	6.8	7.5	8.2	9.1

MLCC

Structure

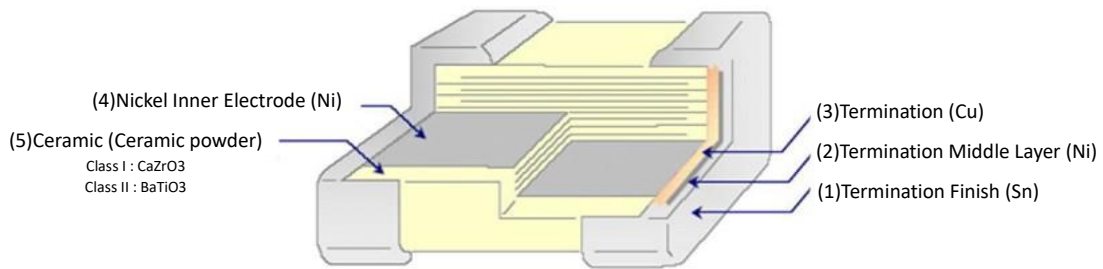

Ordering Code

C 1005 NP0 101 J H T S Δ

PRODUCT CODE

C = MLCC

SIZE in mm (EIA CODE, in inch)

0402 (01005)	0603 (0201)	1005 (0402)	1608 (0603)	2012 (0805)
3216 (1206)	3225 (1210)	4520 (1808)	4532 (1812)	

T. C.

NP0: $0 \pm 30\text{ppm}/^\circ\text{C}$	-55°C to $+125^\circ\text{C}$	X8G: $0 \pm 30\text{ppm}/^\circ\text{C}$	-55°C to $+150^\circ\text{C}$
X5R: $\pm 15\%$	-55°C to $+85^\circ\text{C}$	X6S: $\pm 22\%$	-55°C to $+105^\circ\text{C}$
X7R: $\pm 15\%$	X7S: $\pm 22\%$	X7T: $+22\%/-33\%$	X7U: $+22\%/-56\%$

CAPACITANCE CODE

Expressed in pico-farads and identified by a three-digit number.
 First two digits represent significant figures.
 Last digit specifies the number of zeros.
 (Use 9 for 1.0 through 9.9pF ; Use 8 for 0.20 through 0.99pF)

Examples:

Code	Cap (pF)
478	0.47
229	2.2
101	100
102	1000

TOLERANCE CODE

A: $\pm 0.05\text{pF}$	B: $\pm 0.1\text{pF}$	C: $\pm 0.25\text{pF}$	D: $\pm 0.5\text{pF}$	F: $\pm 1\%$	G: $\pm 2\%$
J: $\pm 5\%$	K: $\pm 10\%$	M: $\pm 20\%$	Z: $+80\%/-20\%$		

VOLTAGE CODE

B: 4V	C: 6.3V	D: 10V	E: 16V	F: 25V	N: 35V	G: 50V	H: 100V
J: 200V	K: 250V	L: 500V	M: 630V	P: 1KV	Q: 2KV	R: 3KV	S: 4KV

PACKAGING CODE

T: Paper tape reel $\varnothing 180\text{mm}$ (7")	P: Embossed tape reel $\varnothing 180\text{mm}$ (7")
N: Paper tape reel $\varnothing 250\text{mm}$ (10")	D: Embossed tape reel $\varnothing 250\text{mm}$ (10")
A: Paper tape reel $\varnothing 330\text{mm}$ (13")	E: Embossed tape reel $\varnothing 330\text{mm}$ (13")
W: Special Packing	

Application Code

S: Standard Q: High Q/Low ESR F: Microwave A: Automotive infotainment with AEC-Q200

Thickness Code

Code	Thick (mm)	Code	Thick(mm)	Code	Thick (mm)
(blank)	Standard Thick	M	0.70	G	1.25
Z	0.20	D	0.80	H	1.50
A	0.30	E	0.85	L	1.60
Q	0.45	I	0.95	N	2.00
B	0.50	J	1.00	P	2.50
C	0.60	F	1.15	R	3.20

Middle-High Voltage (100V~3kV)

■ **Feature**

1. A monolithic structure ensures high reliability and mechanical strength.
2. Suitable for high speed SMT placement on PCBs.
3. RoHS compliant
4. Halogen Free

■ **Application**

1. Input filtering circuit of modem and LAN Interface.
2. DC-DC Converters
3. Backlighting inverters of LCD screen.
4. Switching circuit.
5. General high voltage circuit.

■ **Standard External Dimensions**

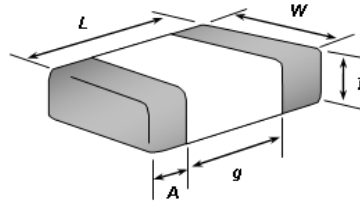

TYPE	Dimension (mm)				
Size (EIA Size)	L (Length)	W (Width)	T(Thickness)	g (Min)	A (Min/Max)
C0603 (0201)	0.6±△	0.3±△	△	0.15	0.10 / 0.25
C1005 (0402)	1.0±△	0.5±△		0.30	0.15 / 0.35
C1608 (0603)	1.6±△	0.8±△		0.50	0.25 / 0.65
C2012 (0805)	2.0±△	1.25±△		0.70	0.25 / 0.75
C3216 (1206)	3.2±△	1.6±△		1.50	0.25 / 0.75
C3225 (1210)	3.5±△	2.5±△		1.50	0.3 / 0.90
C4520 (1808)	4.5±△	2.0±△		2.20	0.3 Min.
C4532 (1812)	4.5±△	3.2±△		2.20	0.3 Min.

△:Please refer to “Part Number & Characteristic”

Part Number & Characteristic

- NP0 Series
- C0603NP0 Series (EIA0201)

RV	DARFON P/N	DARFON P/N 2	Measuring Condition	Capacitance		Available Tolerance	Thick. (mm)	Tolerance(mm)		DF (max.)	Standard Packing	Test Spec.
				Value	Unit			L/W	Thick.			
100V	C0603NP0208□HTS	C0603NP0208□HT	1V, 1MHz	0.20	pF	±0.25pF,±0.1pF,±0.05pF	0.30	±0.03	±0.03	0.25%	Paper,15Kpcs	(I)
	C0603NP0308□HTS	C0603NP0308□HT	1V, 1MHz	0.30	pF	±0.25pF,±0.1pF,±0.05pF	0.30	±0.03	±0.03	0.25%		(I)
	C0603NP0408□HTS	C0603NP0408□HT	1V, 1MHz	0.40	pF	±0.25pF,±0.1pF,±0.05pF	0.30	±0.03	±0.03	0.25%		(I)
	C0603NP0508□HTS	C0603NP0508□HT	1V, 1MHz	0.50	pF	±0.25pF,±0.1pF,±0.05pF	0.30	±0.03	±0.03	0.24%		(I)
	C0603NP0608□HTS	C0603NP0608□HT	1V, 1MHz	0.60	pF	±0.25pF,±0.1pF,±0.05pF	0.30	±0.03	±0.03	0.24%		(I)
	C0603NP0708□HTS	C0603NP0708□HT	1V, 1MHz	0.70	pF	±0.25pF,±0.1pF,±0.05pF	0.30	±0.03	±0.03	0.24%		(I)
	C0603NP0758□HTS	C0603NP0758□HT	1V, 1MHz	0.75	pF	±0.25pF,±0.1pF,±0.05pF	0.30	±0.03	±0.03	0.24%		(I)
	C0603NP0808□HTS	C0603NP0808□HT	1V, 1MHz	0.80	pF	±0.25pF,±0.1pF,±0.05pF	0.30	±0.03	±0.03	0.24%		(I)
	C0603NP0908□HTS	C0603NP0908□HT	1V, 1MHz	0.90	pF	±0.25pF,±0.1pF,±0.05pF	0.30	±0.03	±0.03	0.24%		(I)
	C0603NP109□HTS	C0603NP109□HT	1V, 1MHz	1.0	pF	±0.25pF,±0.1pF,±0.05pF	0.30	±0.03	±0.03	0.24%		(I)
	C0603NP0119□HTS	C0603NP0119□HT	1V, 1MHz	1.1	pF	±0.25pF,±0.1pF	0.30	±0.03	±0.03	0.24%		(I)
	C0603NP0129□HTS	C0603NP0129□HT	1V, 1MHz	1.2	pF	±0.25pF,±0.1pF	0.30	±0.03	±0.03	0.24%		(I)
	C0603NP0139□HTS	C0603NP0139□HT	1V, 1MHz	1.3	pF	±0.25pF,±0.1pF	0.30	±0.03	±0.03	0.23%		(I)
	C0603NP0159□HTS	C0603NP0159□HT	1V, 1MHz	1.5	pF	±0.25pF,±0.1pF	0.30	±0.03	±0.03	0.23%		(I)
	C0603NP0169□HTS	C0603NP0169□HT	1V, 1MHz	1.6	pF	±0.25pF,±0.1pF	0.30	±0.03	±0.03	0.23%		(I)
	C0603NP0189□HTS	C0603NP0189□HT	1V, 1MHz	1.8	pF	±0.25pF,±0.1pF	0.30	±0.03	±0.03	0.23%		(I)
	C0603NP0209□HTS	C0603NP0209□HT	1V, 1MHz	2.0	pF	±0.25pF,±0.1pF	0.30	±0.03	±0.03	0.23%		(I)
	C0603NP0229□HTS	C0603NP0229□HT	1V, 1MHz	2.2	pF	±0.25pF,±0.1pF	0.30	±0.03	±0.03	0.23%		(I)
	C0603NP0249□HTS	C0603NP0249□HT	1V, 1MHz	2.4	pF	±0.25pF,±0.1pF	0.30	±0.03	±0.03	0.22%		(I)
	C0603NP0279□HTS	C0603NP0279□HT	1V, 1MHz	2.7	pF	±0.25pF,±0.1pF	0.30	±0.03	±0.03	0.22%		(I)
	C0603NP0309□HTS	C0603NP0309□HT	1V, 1MHz	3.0	pF	±0.25pF,±0.1pF	0.30	±0.03	±0.03	0.22%		(I)
	C0603NP0339□HTS	C0603NP0339□HT	1V, 1MHz	3.3	pF	±0.25pF,±0.1pF	0.30	±0.03	±0.03	0.21%		(I)
	C0603NP0359□HTS	C0603NP0359□HT	1V, 1MHz	3.5	pF	±0.25pF,±0.1pF	0.30	±0.03	±0.03	0.21%		(I)
	C0603NP0399□HTS	C0603NP0399□HT	1V, 1MHz	3.9	pF	±0.25pF,±0.1pF	0.30	±0.03	±0.03	0.21%		(I)
	C0603NP0409□HTS	C0603NP0409□HT	1V, 1MHz	4.0	pF	±0.25pF,±0.1pF	0.30	±0.03	±0.03	0.21%		(I)
	C0603NP0439□HTS	C0603NP0439□HT	1V, 1MHz	4.3	pF	±0.25pF,±0.1pF	0.30	±0.03	±0.03	0.21%		(I)
	C0603NP0479□HTS	C0603NP0479□HT	1V, 1MHz	4.7	pF	±0.25pF,±0.1pF	0.30	±0.03	±0.03	0.20%		(I)
	C0603NP0509□HTS	C0603NP0509□HT	1V, 1MHz	5.0	pF	±0.5pF,±0.25pF,±0.1pF	0.30	±0.03	±0.03	0.20%		(I)
	C0603NP0519□HTS	C0603NP0519□HT	1V, 1MHz	5.1	pF	±0.5pF,±0.25pF,±0.1pF	0.30	±0.03	±0.03	0.20%		(I)
	C0603NP0569□HTS	C0603NP0569□HT	1V, 1MHz	5.6	pF	±0.5pF,±0.25pF,±0.1pF	0.30	±0.03	±0.03	0.20%		(I)
	C0603NP0609□HTS	C0603NP0609□HT	1V, 1MHz	6.0	pF	±0.5pF,±0.25pF,±0.1pF	0.30	±0.03	±0.03	0.19%		(I)
	C0603NP0689□HTS	C0603NP0689□HT	1V, 1MHz	6.8	pF	±0.5pF,±0.25pF,±0.1pF	0.30	±0.03	±0.03	0.19%		(I)
	C0603NP0709□HTS	C0603NP0709□HT	1V, 1MHz	7.0	pF	±0.5pF,±0.25pF,±0.1pF	0.30	±0.03	±0.03	0.19%		(I)
	C0603NP0759□HTS	C0603NP0759□HT	1V, 1MHz	7.5	pF	±0.5pF,±0.25pF,±0.1pF	0.30	±0.03	±0.03	0.18%		(I)
	C0603NP0809□HTS	C0603NP0809□HT	1V, 1MHz	8.0	pF	±0.5pF,±0.25pF,±0.1pF	0.30	±0.03	±0.03	0.18%		(I)
	C0603NP0829□HTS	C0603NP0829□HT	1V, 1MHz	8.2	pF	±0.5pF,±0.25pF,±0.1pF	0.30	±0.03	±0.03	0.18%		(I)
	C0603NP0909□HTS	C0603NP0909□HT	1V, 1MHz	9.0	pF	±0.5pF,±0.25pF,±0.1pF	0.30	±0.03	±0.03	0.17%		(I)
	C0603NP0100□HTS	C0603NP0100□HT	1V, 1MHz	10	pF	±5%,±2%,±1%	0.30	±0.03	±0.03	0.17%		(I)
	C0603NP0120□HTS	C0603NP0120□HT	1V, 1MHz	12	pF	±5%,±2%	0.30	±0.03	±0.03	0.16%		(I)
	C0603NP0130JHTS	C0603NP0130JHT	1V, 1MHz	13	pF	±5%	0.30	±0.03	±0.03	0.15%		(I)
	C0603NP0150JHTS	C0603NP0150JHT	1V, 1MHz	15	pF	±5%	0.30	±0.03	±0.03	0.14%		(I)
	C0603NP0180JHTS	C0603NP0180JHT	1V, 1MHz	18	pF	±5%	0.30	±0.03	±0.03	0.13%		(I)
	C0603NP0220JHTS	C0603NP0220JHT	1V, 1MHz	22	pF	±5%	0.30	±0.03	±0.03	0.12%		(I)
	C0603NP0270JHTS	C0603NP0270JHT	1V, 1MHz	27	pF	±5%	0.30	±0.03	±0.03	0.11%		(I)
	C0603NP0330JHTS	C0603NP0330JHT	1V, 1MHz	33	pF	±5%	0.30	±0.03	±0.03	0.10%		(I)
	C0603NP0390JHTS	C0603NP0390JHT	1V, 1MHz	39	pF	±5%	0.30	±0.03	±0.03	0.10%		(I)
	C0603NP0470□HTS	C0603NP0470□HT	1V, 1MHz	47	pF	±5%,±2%	0.30	±0.03	±0.03	0.10%		(I)
	C0603NP0560JHTS	C0603NP0560JHT	1V, 1MHz	56	pF	±5%	0.30	±0.03	±0.03	0.10%		(I)
C0603NP0680JHTS	C0603NP0680JHT	1V, 1MHz	68	pF	±5%	0.30	±0.03	±0.03	0.10%	(I)		
C0603NP0820JHTS	C0603NP0820JHT	1V, 1MHz	82	pF	±5%	0.30	±0.03	±0.03	0.10%	(I)		
C0603NP0101□HTS	C0603NP0101□HT	1V, 1MHz	100	pF	±10%,±5%,±2%	0.30	±0.03	±0.03	0.10%	(I)		
C0603NP0121JHTS	C0603NP0121JHT	1V, 1MHz	120	pF	±5%	0.30	±0.03	±0.03	0.10%	(I)		
C0603NP0151JHTS	C0603NP0151JHT	1V, 1MHz	150	pF	±5%	0.30	±0.03	±0.03	0.10%	(I)		
C0603NP0181JHTS	C0603NP0181JHT	1V, 1MHz	180	pF	±5%	0.30	±0.03	±0.03	0.10%	(I)		
C0603NP0221JHTS	C0603NP0221JHT	1V, 1MHz	220	pF	±5%	0.30	±0.03	±0.03	0.10%	(I)		
C0603NP0241JHTS	C0603NP0241JHT	1V, 1MHz	240	pF	±5%	0.30	±0.03	±0.03	0.10%	(I)		

□ Tolerance Code: A=±0.05 pF, B=±0.1pF, C=±0.25pF, D=±0.5pF, G=±2%, J=±5%; Special tolerance on the request.

● C1005NP0 Series (EIA0402)

RV	DARFON P/N	DARFON P/N 2	Measuring Condition	Capacitance		Available Tolerance	Thick. (mm)	Tolerance(mm)		DF (max.)	Standard Packing	Test Spec.
				Value	Unit			L/W	Thick.			
200V	C1005NP0309CJTS	C1005NP0309CJT	1V, 1MHz	3.0	pF	±0.25pF	0.50	±0.05	±0.05	0.22%	Paper, 10Kpcs	(I)
	C1005NP0150JTS	C1005NP0150JJT	1V, 1MHz	15	pF	±5%	0.50	±0.05	±0.05	0.14%		(I)
	C1005NP0240□JTS	C1005NP0240□JT	1V, 1MHz	24	pF	±5%, ±2%, ±1%	0.50	±0.05	±0.05	0.11%		(I)
	C1005NP0221JTS	C1005NP0221JJT	1V, 1MHz	220	pF	±5%	0.50	±0.05	±0.05	0.10%		(I)
	C1005NP0271JTS	C1005NP0271JJT	1V, 1MHz	270	pF	±5%	0.50	±0.05	±0.05	0.10%		(I)
	C1005NP0331JTS	C1005NP0331JJT	1V, 1MHz	330	pF	±5%	0.50	±0.05	±0.05	0.10%		(I)
	C1005NP0391JTS	C1005NP0391JJT	1V, 1MHz	390	pF	±5%	0.50	±0.05	±0.05	0.10%	(I)	
100V	C1005NP0208□HTS	C1005NP0208□HT	1V, 1MHz	0.20	pF	±0.25pF, ±0.1pF, ±0.05pF	0.50	±0.05	±0.05	0.25%	Paper, 10Kpcs	(I)
	C1005NP0308□HTS	C1005NP0308□HT	1V, 1MHz	0.30	pF	±0.25pF, ±0.1pF, ±0.05pF	0.50	±0.05	±0.05	0.25%		(I)
	C1005NP0408□HTS	C1005NP0408□HT	1V, 1MHz	0.40	pF	±0.25pF, ±0.1pF, ±0.05pF	0.50	±0.05	±0.05	0.25%		(I)
	C1005NP0508□HTS	C1005NP0508□HT	1V, 1MHz	0.50	pF	±0.25pF, ±0.1pF, ±0.05pF	0.50	±0.05	±0.05	0.24%		(I)
	C1005NP0608□HTS	C1005NP0608□HT	1V, 1MHz	0.60	pF	±0.25pF, ±0.1pF, ±0.05pF	0.50	±0.05	±0.05	0.24%		(I)
	C1005NP0708□HTS	C1005NP0708□HT	1V, 1MHz	0.70	pF	±0.25pF, ±0.1pF, ±0.05pF	0.50	±0.05	±0.05	0.24%		(I)
	C1005NP0808□HTS	C1005NP0808□HT	1V, 1MHz	0.80	pF	±0.25pF, ±0.1pF, ±0.05pF	0.50	±0.05	±0.05	0.24%		(I)
	C1005NP0908□HTS	C1005NP0908□HT	1V, 1MHz	0.90	pF	±0.25pF, ±0.1pF, ±0.05pF	0.50	±0.05	±0.05	0.24%		(I)
	C1005NP0109□HTS	C1005NP0109□HT	1V, 1MHz	1.0	pF	±0.25pF, ±0.1pF, ±0.05pF	0.50	±0.05	±0.05	0.24%		(I)
	C1005NP0129□HTS	C1005NP0129□HT	1V, 1MHz	1.2	pF	±0.25pF, ±0.1pF	0.50	±0.05	±0.05	0.24%		(I)
	C1005NP0159□HTS	C1005NP0159□HT	1V, 1MHz	1.5	pF	±0.25pF, ±0.1pF	0.50	±0.05	±0.05	0.23%		(I)
	C1005NP0189□HTS	C1005NP0189□HT	1V, 1MHz	1.8	pF	±0.25pF, ±0.1pF	0.50	±0.05	±0.05	0.23%		(I)
	C1005NP0229□HTS	C1005NP0229□HT	1V, 1MHz	2.2	pF	±0.25pF, ±0.1pF	0.50	±0.05	±0.05	0.23%		(I)
	C1005NP0279□HTS	C1005NP0279□HT	1V, 1MHz	2.7	pF	±0.25pF, ±0.1pF	0.50	±0.05	±0.05	0.22%		(I)
	C1005NP0339□HTS	C1005NP0339□HT	1V, 1MHz	3.3	pF	±0.25pF, ±0.1pF	0.50	±0.05	±0.05	0.21%		(I)
	C1005NP0399□HTS	C1005NP0399□HT	1V, 1MHz	3.9	pF	±0.25pF, ±0.1pF	0.50	±0.05	±0.05	0.21%		(I)
	C1005NP0409□HTS	C1005NP0409□HT	1V, 1MHz	4.0	pF	±0.25pF, ±0.1pF	0.50	±0.05	±0.05	0.21%		(I)
	C1005NP0479□HTS	C1005NP0479□HT	1V, 1MHz	4.7	pF	±0.25pF, ±0.1pF	0.50	±0.05	±0.05	0.20%		(I)
	C1005NP0509□HTS	C1005NP0509□HT	1V, 1MHz	5.0	pF	±0.5pF, ±0.25pF, ±0.1pF	0.50	±0.05	±0.05	0.20%		(I)
	C1005NP0569□HTS	C1005NP0569□HT	1V, 1MHz	5.6	pF	±0.5pF, ±0.25pF, ±0.1pF	0.50	±0.05	±0.05	0.20%		(I)
	C1005NP0689□HTS	C1005NP0689□HT	1V, 1MHz	6.8	pF	±0.5pF, ±0.25pF, ±0.1pF	0.50	±0.05	±0.05	0.19%		(I)
	C1005NP0809□HTS	C1005NP0809□HT	1V, 1MHz	8.0	pF	±0.5pF, ±0.25pF, ±0.1pF	0.50	±0.05	±0.05	0.18%		(I)
	C1005NP0829□HTS	C1005NP0829□HT	1V, 1MHz	8.2	pF	±0.5pF, ±0.25pF, ±0.1pF	0.50	±0.05	±0.05	0.18%		(I)
	C1005NP0100□HTS	C1005NP0100□HT	1V, 1MHz	10	pF	±5%, ±2%, ±1%	0.50	±0.05	±0.05	0.17%		(I)
	C1005NP0120□HTS	C1005NP0120□HT	1V, 1MHz	12	pF	±5%, ±2%, ±1%	0.50	±0.05	±0.05	0.16%		(I)
	C1005NP0150□HTS	C1005NP0150□HT	1V, 1MHz	15	pF	±5%, ±2%, ±1%	0.50	±0.05	±0.05	0.14%		(I)
	C1005NP0160□HTS	C1005NP0160□HT	1V, 1MHz	16	pF	±5%, ±2%	0.50	±0.05	±0.05	0.14%		(I)
	C1005NP0180□HTS	C1005NP0180□HT	1V, 1MHz	18	pF	±5%, ±2%, ±1%	0.50	±0.05	±0.05	0.13%		(I)
	C1005NP0220□HTS	C1005NP0220□HT	1V, 1MHz	22	pF	±5%, ±2%, ±1%	0.50	±0.05	±0.05	0.12%		(I)
	C1005NP0270□HTS	C1005NP0270□HT	1V, 1MHz	27	pF	±5%, ±2%, ±1%	0.50	±0.05	±0.05	0.11%		(I)
	C1005NP0330□HTS	C1005NP0330□HT	1V, 1MHz	33	pF	±5%, ±2%, ±1%	0.50	±0.05	±0.05	0.10%		(I)
	C1005NP0390□HTS	C1005NP0390□HT	1V, 1MHz	39	pF	±5%, ±2%, ±1%	0.50	±0.05	±0.05	0.10%		(I)
	C1005NP0470□HTS	C1005NP0470□HT	1V, 1MHz	47	pF	±5%, ±2%, ±1%	0.50	±0.05	±0.05	0.10%		(I)
	C1005NP0560□HTS	C1005NP0560□HT	1V, 1MHz	56	pF	±5%, ±2%, ±1%	0.50	±0.05	±0.05	0.10%		(I)
	C1005NP0680□HTS	C1005NP0680□HT	1V, 1MHz	68	pF	±5%, ±2%, ±1%	0.50	±0.05	±0.05	0.10%		(I)
	C1005NP0820□HTS	C1005NP0820□HT	1V, 1MHz	82	pF	±5%, ±2%, ±1%	0.50	±0.05	±0.05	0.10%		(I)
	C1005NP0101□HTS	C1005NP0101□HT	1V, 1MHz	100	pF	±5%, ±2%, ±1%	0.50	±0.05	±0.05	0.10%		(I)
	C1005NP0121□HTS	C1005NP0121□HT	1V, 1MHz	120	pF	±5%, ±2%, ±1%	0.50	±0.05	±0.05	0.10%		(I)
	C1005NP0151JHTS	C1005NP0151JHT	1V, 1MHz	150	pF	±5%	0.50	±0.05	±0.05	0.10%		(I)
	C1005NP0181JHTS	C1005NP0181JHT	1V, 1MHz	180	pF	±5%	0.50	±0.05	±0.05	0.10%		(I)
	C1005NP0221JHTS	C1005NP0221JHT	1V, 1MHz	220	pF	±5%	0.50	±0.05	±0.05	0.10%		(I)
	C1005NP0271JHTS	C1005NP0271JHT	1V, 1MHz	270	pF	±5%	0.50	±0.05	±0.05	0.10%		(I)
C1005NP0331JHTS	C1005NP0331JHT	1V, 1MHz	330	pF	±5%	0.50	±0.05	±0.05	0.10%	(I)		
C1005NP0391JHTS	C1005NP0391JHT	1V, 1MHz	390	pF	±5%	0.50	±0.05	±0.05	0.10%	(I)		
C1005NP0471JHTS	C1005NP0471JHT	1V, 1MHz	470	pF	±5%	0.50	±0.05	±0.05	0.10%	(I)		
C1005NP0561JHTS	C1005NP0561JHT	1V, 1MHz	560	pF	±5%	0.50	±0.05	±0.05	0.10%	(I)		
C1005NP0681□HTS	C1005NP0681□HT	1V, 1MHz	680	pF	±5%, ±2%, ±1%	0.50	±0.05	±0.05	0.10%	(I)		
C1005NP0751JHTS	C1005NP0751JHT	1V, 1MHz	750	pF	±5%	0.50	±0.05	±0.05	0.10%	(I)		
C1005NP0821JHTS	C1005NP0821JHT	1V, 1MHz	820	pF	±5%	0.50	±0.05	±0.05	0.10%	(I)		
C1005NP0102□HTS	C1005NP0102□HT	1V, 1MHz	1.0	nF	±5%, ±2%	0.50	±0.05	±0.05	0.10%	(I)		
C1005NP0152JHTS	C1005NP0152JHT	1V, 1kHz	1.5	nF	±5%	0.50	±0.05	±0.05	0.10%	(I)		

□ Tolerance Code: A=±0.05 pF, B=±0.1pF, C=±0.25pF, D=±0.5pF, G=±2%, J=±5%; Special tolerance on the request.

● C1608NP0 Series (EIA0603)

RV	DARFON P/N	DARFON P/N 2	Measuring Condition	Capacitance		Available Tolerance	Thick. (mm)	Tolerance(mm)		DF (max.)	Standard Packing	Test Spec.
				Value	Unit			L/W	Thick.			
250V	C1608NP0109□KTS	C1608NP0109□KT	1V, 1MHz	1.0	pF	±0.25pF,±0.1pF	0.80	±0.10	±0.10	0.24%	Paper, 4Kpcs	(I)
	C1608NP0129□KTS	C1608NP0129□KT	1V, 1MHz	1.2	pF	±0.25pF,±0.1pF	0.80	±0.10	±0.10	0.24%		(I)
	C1608NP0159□KTS	C1608NP0159□KT	1V, 1MHz	1.5	pF	±0.25pF,±0.1pF	0.80	±0.10	±0.10	0.23%		(I)
	C1608NP0189□KTS	C1608NP0189□KT	1V, 1MHz	1.8	pF	±0.25pF,±0.1pF	0.80	±0.10	±0.10	0.23%		(I)
	C1608NP0229□KTS	C1608NP0229□KT	1V, 1MHz	2.2	pF	±0.25pF,±0.1pF	0.80	±0.10	±0.10	0.23%		(I)
	C1608NP0279□KTS	C1608NP0279□KT	1V, 1MHz	2.7	pF	±0.25pF,±0.1pF	0.80	±0.10	±0.10	0.22%		(I)
	C1608NP0339□KTS	C1608NP0339□KT	1V, 1MHz	3.3	pF	±0.25pF,±0.1pF	0.80	±0.10	±0.10	0.21%		(I)
	C1608NP0399□KTS	C1608NP0399□KT	1V, 1MHz	3.9	pF	±0.25pF,±0.1pF	0.80	±0.10	±0.10	0.21%		(I)
	C1608NP0479□KTS	C1608NP0479□KT	1V, 1MHz	4.7	pF	±0.25pF,±0.1pF	0.80	±0.10	±0.10	0.20%		(I)
	C1608NP0569□KTS	C1608NP0569□KT	1V, 1MHz	5.6	pF	±0.5pF,±0.25pF	0.80	±0.10	±0.10	0.20%		(I)
	C1608NP0689□KTS	C1608NP0689□KT	1V, 1MHz	6.8	pF	±0.5pF,±0.25pF	0.80	±0.10	±0.10	0.19%		(I)
	C1608NP0829□KTS	C1608NP0829□KT	1V, 1MHz	8.2	pF	±0.5pF,±0.25pF	0.80	±0.10	±0.10	0.18%		(I)
	C1608NP0100JKTS	C1608NP0100JKT	1V, 1MHz	10	pF	±5%	0.80	±0.10	±0.10	0.17%		(I)
	C1608NP0120JKTS	C1608NP0120JKT	1V, 1MHz	12	pF	±5%	0.80	±0.10	±0.10	0.16%		(I)
	C1608NP0150JKTS	C1608NP0150JKT	1V, 1MHz	15	pF	±5%	0.80	±0.10	±0.10	0.14%		(I)
	C1608NP0180JKTS	C1608NP0180JKT	1V, 1MHz	18	pF	±5%	0.80	±0.10	±0.10	0.13%		(I)
	C1608NP0220JKTS	C1608NP0220JKT	1V, 1MHz	22	pF	±5%	0.80	±0.10	±0.10	0.12%		(I)
	C1608NP0270JKTS	C1608NP0270JKT	1V, 1MHz	27	pF	±5%	0.80	±0.10	±0.10	0.11%		(I)
	C1608NP0330JKTS	C1608NP0330JKT	1V, 1MHz	33	pF	±5%	0.80	±0.10	±0.10	0.10%		(I)
	C1608NP0390JKTS	C1608NP0390JKT	1V, 1MHz	39	pF	±5%	0.80	±0.10	±0.10	0.10%		(I)
	C1608NP0470JKTS	C1608NP0470JKT	1V, 1MHz	47	pF	±5%	0.80	±0.10	±0.10	0.10%		(I)
	C1608NP0560JKTS	C1608NP0560JKT	1V, 1MHz	56	pF	±5%	0.80	±0.10	±0.10	0.10%		(I)
	C1608NP0680JKTS	C1608NP0680JKT	1V, 1MHz	68	pF	±5%	0.80	±0.10	±0.10	0.10%		(I)
	C1608NP0820JKTS	C1608NP0820JKT	1V, 1MHz	82	pF	±5%	0.80	±0.10	±0.10	0.10%		(I)
	C1608NP0101JKTS	C1608NP0101JKT	1V, 1MHz	100	pF	±5%	0.80	±0.10	±0.10	0.10%		(I)
	C1608NP0121JKTS	C1608NP0121JKT	1V, 1MHz	120	pF	±5%	0.80	±0.10	±0.10	0.10%		(I)
	C1608NP0151JKTS	C1608NP0151JKT	1V, 1MHz	150	pF	±5%	0.80	±0.10	±0.10	0.10%		(I)
	C1608NP0181JKTS	C1608NP0181JKT	1V, 1MHz	180	pF	±5%	0.80	±0.10	±0.10	0.10%		(I)
	C1608NP0221JKTS	C1608NP0221JKT	1V, 1MHz	220	pF	±5%	0.80	±0.10	±0.10	0.10%		(I)
	C1608NP0271JKTS	C1608NP0271JKT	1V, 1MHz	270	pF	±5%	0.80	±0.15	±0.15	0.10%		(I)
	C1608NP0331JKTS	C1608NP0331JKT	1V, 1MHz	330	pF	±5%	0.80	±0.15	±0.15	0.10%		(I)
	C1608NP0391JKTS	C1608NP0391JKT	1V, 1MHz	390	pF	±5%	0.80	±0.15	±0.15	0.10%		(I)
C1608NP0471JKTS	C1608NP0471JKT	1V, 1MHz	470	pF	±5%	0.80	±0.15	±0.15	0.10%	(I)		
C1608NP0561JKTS	C1608NP0561JKT	1V, 1MHz	560	pF	±5%	0.80	±0.15	±0.15	0.10%	(I)		
C1608NP0681JKTS	C1608NP0681JKT	1V, 1MHz	680	pF	±5%	0.80	±0.15	±0.15	0.10%	(I)		
C1608NP0821JKTS	C1608NP0821JKT	1V, 1MHz	820	pF	±5%	0.80	±0.15	±0.15	0.10%	(I)		
C1608NP0102JKTS	C1608NP0102JKT	1V, 1MHz	1.0	nF	±5%	0.80	±0.15	±0.15	0.10%	(I)		
C1608NP0122JKTS	C1608NP0122JKT	1V, 1kHz	1.2	nF	±5%	0.80	±0.15	±0.15	0.10%	(I)		
C1608NP0222JKTS	C1608NP0222JKT	1V, 1kHz	2.2	nF	±5%	0.80	±0.15	±0.15	0.10%	(I)		
200V	C1608NP0109BJTS	C1608NP0109BJT	1V, 1MHz	1.0	pF	±0.1pF	0.80	±0.10	±0.10	0.24%	Paper, 4Kpcs	(I)
	C1608NP0101□JTS	C1608NP0101□JT	1V, 1MHz	100	pF	±5%,±2%,±1%	0.80	±0.10	±0.10	0.10%		(I)
	C1608NP0151□JTS	C1608NP0151□JT	1V, 1MHz	150	pF	±5%,±2%,±1%	0.80	±0.10	±0.10	0.10%		(I)
	C1608NP0221□JTS	C1608NP0221□JT	1V, 1MHz	220	pF	±5%,±2%,±1%	0.80	±0.10	±0.10	0.10%		(I)
C1608NP0331□JTS	C1608NP0331□JT	1V, 1MHz	330	pF	±5%,±2%,±1%	0.80	±0.10	±0.10	0.10%	(I)		

□ Tolerance Code: A=±0.05 pF, B=±0.1pF, C=±0.25pF, D=±0.5pF, G=±2%, J=±5%; Special tolerance on the request.

RV	DARFON P/N	DARFON P/N 2	Measuring Condition	Capacitance		Available Tolerance	Thick. (mm)	Tolerance(mm)		DF (max.)	Standard Packing	Test Spec.
				Value	Unit			L/W	Thick.			
100V	C1608NP0308□HTS	C1608NP0308□HT	1V, 1MHz	0.30	pF	±0.25pF,±0.1pF,±0.05pF	0.80	±0.10	±0.10	0.25%		(I)
	C1608NP0408□HTS	C1608NP0408□HT	1V, 1MHz	0.40	pF	±0.25pF,±0.1pF,±0.05pF	0.80	±0.10	±0.10	0.25%		(I)
	C1608NP0508□HTS	C1608NP0508□HT	1V, 1MHz	0.50	pF	±0.25pF,±0.1pF,±0.05pF	0.80	±0.10	±0.10	0.24%		(I)
	C1608NP0608□HTS	C1608NP0608□HT	1V, 1MHz	0.60	pF	±0.25pF,±0.1pF,±0.05pF	0.80	±0.10	±0.10	0.24%		(I)
	C1608NP0708□HTS	C1608NP0708□HT	1V, 1MHz	0.70	pF	±0.25pF,±0.1pF,±0.05pF	0.80	±0.10	±0.10	0.24%		(I)
	C1608NP0758□HTS	C1608NP0758□HT	1V, 1MHz	0.75	pF	±0.25pF,±0.1pF,±0.05pF	0.80	±0.10	±0.10	0.24%		(I)
	C1608NP0808□HTS	C1608NP0808□HT	1V, 1MHz	0.80	pF	±0.25pF,±0.1pF,±0.05pF	0.80	±0.10	±0.10	0.24%		(I)
	C1608NP0908□HTS	C1608NP0908□HT	1V, 1MHz	0.90	pF	±0.25pF,±0.1pF,±0.05pF	0.80	±0.10	±0.10	0.24%		(I)
	C1608NP0109□HTS	C1608NP0109□HT	1V, 1MHz	1.0	pF	±0.25pF,±0.1pF,±0.05pF	0.80	±0.10	±0.10	0.24%		(I)
	C1608NP0129□HTS	C1608NP0129□HT	1V, 1MHz	1.2	pF	±0.25pF,±0.1pF	0.80	±0.10	±0.10	0.24%		(I)
	C1608NP0159□HTS	C1608NP0159□HT	1V, 1MHz	1.5	pF	±0.25pF,±0.1pF	0.80	±0.10	±0.10	0.23%		(I)
	C1608NP0189□HTS	C1608NP0189□HT	1V, 1MHz	1.8	pF	±0.25pF,±0.1pF	0.80	±0.10	±0.10	0.23%		(I)
	C1608NP0209□HTS	C1608NP0209□HT	1V, 1MHz	2.0	pF	±0.25pF,±0.1pF	0.80	±0.10	±0.10	0.23%		(I)
	C1608NP0229□HTS	C1608NP0229□HT	1V, 1MHz	2.2	pF	±0.25pF,±0.1pF	0.80	±0.10	±0.10	0.23%		(I)
	C1608NP0249□HTS	C1608NP0249□HT	1V, 1MHz	2.4	pF	±0.25pF,±0.1pF	0.80	±0.10	±0.10	0.22%		(I)
	C1608NP0279□HTS	C1608NP0279□HT	1V, 1MHz	2.7	pF	±0.25pF,±0.1pF	0.80	±0.10	±0.10	0.22%		(I)
	C1608NP0309□HTS	C1608NP0309□HT	1V, 1MHz	3.0	pF	±0.25pF,±0.1pF	0.80	±0.10	±0.10	0.22%		(I)
	C1608NP0339□HTS	C1608NP0339□HT	1V, 1MHz	3.3	pF	±0.25pF,±0.1pF	0.80	±0.10	±0.10	0.21%		(I)
	C1608NP0369CHTS	C1608NP0369CHT	1V, 1MHz	3.6	pF	±0.25pF	0.80	±0.10	±0.10	0.21%		(I)
	C1608NP0399□HTS	C1608NP0399□HT	1V, 1MHz	3.9	pF	±0.25pF,±0.1pF	0.80	±0.10	±0.10	0.21%		(I)
	C1608NP0409□HTS	C1608NP0409□HT	1V, 1MHz	4.0	pF	±0.25pF,±0.1pF	0.80	±0.10	±0.10	0.21%		(I)
	C1608NP0439□HTS	C1608NP0439□HT	1V, 1MHz	4.3	pF	±0.25pF,±0.1pF	0.80	±0.10	±0.10	0.21%		(I)
	C1608NP0479□HTS	C1608NP0479□HT	1V, 1MHz	4.7	pF	±0.25pF,±0.1pF,±0.05pF	0.80	±0.10	±0.10	0.20%		(I)
	C1608NP0509□HTS	C1608NP0509□HT	1V, 1MHz	5.0	pF	±0.5pF,±0.25pF,±0.1pF	0.80	±0.10	±0.10	0.20%		(I)
	C1608NP0569□HTS	C1608NP0569□HT	1V, 1MHz	5.6	pF	±0.5pF,±0.25pF,±0.1pF	0.80	±0.10	±0.10	0.20%		(I)
	C1608NP0609□HTS	C1608NP0609□HT	1V, 1MHz	6.0	pF	±0.5pF,±0.25pF,±0.1pF	0.80	±0.10	±0.10	0.19%		(I)
	C1608NP0629□HTS	C1608NP0629□HT	1V, 1MHz	6.2	pF	±0.5pF,±0.25pF,±0.1pF	0.80	±0.10	±0.10	0.19%		(I)
	C1608NP0689□HTS	C1608NP0689□HT	1V, 1MHz	6.8	pF	±0.5pF,±0.25pF,±0.1pF	0.80	±0.10	±0.10	0.19%		(I)
	C1608NP0709□HTS	C1608NP0709□HT	1V, 1MHz	7.0	pF	±0.5pF,±0.25pF,±0.1pF	0.80	±0.10	±0.10	0.19%		(I)
	C1608NP0809CHTS	C1608NP0809CHT	1V, 1MHz	8.0	pF	±0.25pF	0.80	±0.10	±0.10	0.18%		(I)
	C1608NP0829□HTS	C1608NP0829□HT	1V, 1MHz	8.2	pF	±0.5pF,±0.25pF,±0.1pF	0.80	±0.10	±0.10	0.18%		(I)
	C1608NP0909□HTS	C1608NP0909□HT	1V, 1MHz	9.0	pF	±0.5pF,±0.25pF,±0.1pF	0.80	±0.10	±0.10	0.17%		(I)
	C1608NP0919□HTS	C1608NP0919□HT	1V, 1MHz	9.1	pF	±0.5pF,±0.25pF,±0.1pF	0.80	±0.10	±0.10	0.17%		(I)
	C1608NP0100□HTS	C1608NP0100□HT	1V, 1MHz	10	pF	±5%,±2%,±1%	0.80	±0.10	±0.10	0.17%		(I)
	C1608NP0110□HTS	C1608NP0110□HT	1V, 1MHz	11	pF	±5%,±2%,±1%	0.80	±0.10	±0.10	0.16%		(I)
	C1608NP0120□HTS	C1608NP0120□HT	1V, 1MHz	12	pF	±5%,±2%,±1%	0.80	±0.10	±0.10	0.16%		(I)
	C1608NP0150□HTS	C1608NP0150□HT	1V, 1MHz	15	pF	±5%,±2%,±1%	0.80	±0.10	±0.10	0.14%		(I)
	C1608NP0160GHTS	C1608NP0160GHT	1V, 1MHz	16	pF	±2%	0.80	±0.10	±0.10	0.14%		(I)
	C1608NP0180□HTS	C1608NP0180□HT	1V, 1MHz	18	pF	±5%,±2%,±1%	0.80	±0.10	±0.10	0.13%		(I)
	C1608NP0200□HTS	C1608NP0200□HT	1V, 1MHz	20	pF	±5%,±2%,±1%	0.80	±0.10	±0.10	0.13%		(I)
	C1608NP0220□HTS	C1608NP0220□HT	1V, 1MHz	22	pF	±5%,±2%,±1%	0.80	±0.10	±0.10	0.12%		(I)
	C1608NP0240□HTS	C1608NP0240□HT	1V, 1MHz	24	pF	±5%,±2%,±1%	0.80	±0.10	±0.10	0.11%		(I)
	C1608NP0270□HTS	C1608NP0270□HT	1V, 1MHz	27	pF	±5%,±2%,±1%	0.80	±0.10	±0.10	0.11%		(I)
	C1608NP0300□HTS	C1608NP0300□HT	1V, 1MHz	30	pF	±5%,±2%,±1%	0.80	±0.10	±0.10	0.10%		(I)
	C1608NP0330□HTS	C1608NP0330□HT	1V, 1MHz	33	pF	±5%,±2%,±1%	0.80	±0.10	±0.10	0.10%		(I)
	C1608NP0360□HTS	C1608NP0360□HT	1V, 1MHz	36	pF	±5%,±2%,±1%	0.80	±0.10	±0.10	0.10%		(I)
	C1608NP0390□HTS	C1608NP0390□HT	1V, 1MHz	39	pF	±5%,±2%,±1%	0.80	±0.10	±0.10	0.10%		(I)
	C1608NP0430□HTS	C1608NP0430□HT	1V, 1MHz	43	pF	±5%,±2%,±1%	0.80	±0.10	±0.10	0.10%		(I)
	C1608NP0470□HTS	C1608NP0470□HT	1V, 1MHz	47	pF	±5%,±2%,±1%	0.80	±0.10	±0.10	0.10%		(I)
	C1608NP0560□HTS	C1608NP0560□HT	1V, 1MHz	56	pF	±5%,±2%,±1%	0.80	±0.10	±0.10	0.10%		(I)
C1608NP0620□HTS	C1608NP0620□HT	1V, 1MHz	62	pF	±5%,±2%,±1%	0.80	±0.10	±0.10	0.10%		(I)	
C1608NP0680□HTS	C1608NP0680□HT	1V, 1MHz	68	pF	±5%,±2%,±1%	0.80	±0.10	±0.10	0.10%		(I)	
C1608NP0750□HTS	C1608NP0750□HT	1V, 1MHz	75	pF	±5%,±2%,±1%	0.80	±0.10	±0.10	0.10%		(I)	
C1608NP0820□HTS	C1608NP0820□HT	1V, 1MHz	82	pF	±5%,±2%,±1%	0.80	±0.10	±0.10	0.10%		(I)	
C1608NP0910□HTS	C1608NP0910□HT	1V, 1MHz	91	pF	±5%,±2%,±1%	0.80	±0.10	±0.10	0.10%		(I)	
C1608NP0101□HTS	C1608NP0101□HT	1V, 1MHz	100	pF	±5%,±2%,±1%	0.80	±0.10	±0.10	0.10%		(I)	
C1608NP0121□HTS	C1608NP0121□HT	1V, 1MHz	120	pF	±5%,±2%,±1%	0.80	±0.10	±0.10	0.10%		(I)	
C1608NP0151□HTS	C1608NP0151□HT	1V, 1MHz	150	pF	±5%,±2%,±1%	0.80	±0.10	±0.10	0.10%		(I)	
C1608NP0181JHTS	C1608NP0181JHT	1V, 1MHz	180	pF	±5%	0.80	±0.10	±0.10	0.10%		(I)	
C1608NP0201JHTS	C1608NP0201JHT	1V, 1MHz	200	pF	±5%	0.80	±0.10	±0.10	0.10%		(I)	
C1608NP0221□HTS	C1608NP0221□HT	1V, 1MHz	220	pF	±5%,±2%,±1%	0.80	±0.10	±0.10	0.10%		(I)	
C1608NP0271JHTS	C1608NP0271JHT	1V, 1MHz	270	pF	±5%	0.80	±0.10	±0.10	0.10%		(I)	
C1608NP0331JHTS	C1608NP0331JHT	1V, 1MHz	330	pF	±5%	0.80	±0.10	±0.10	0.10%		(I)	
C1608NP0391JHTS	C1608NP0391JHT	1V, 1MHz	390	pF	±5%	0.80	±0.10	±0.10	0.10%		(I)	
C1608NP0471□HTS	C1608NP0471□HT	1V, 1MHz	470	pF	±5%,±2%,±1%	0.80	±0.10	±0.10	0.10%		(I)	
C1608NP0561JHTS	C1608NP0561JHT	1V, 1MHz	560	pF	±5%	0.80	±0.10	±0.10	0.10%		(I)	
C1608NP0681JHTS	C1608NP0681JHT	1V, 1MHz	680	pF	±5%	0.80	±0.10	±0.10	0.10%		(I)	
C1608NP0821JHTS	C1608NP0821JHT	1V, 1MHz	820	pF	±5%	0.80	±0.10	±0.10	0.10%		(I)	
C1608NP0102□HTS	C1608NP0102□HT	1V, 1MHz	1.0	nF	±5%,±2%,±1%	0.80	±0.10	±0.10	0.10%		(I)	
C1608NP0122JHTS	C1608NP0122JHT	1V, 1KHz	1.2	nF	±5%	0.80	+0.15/-0.10	+0.15/-0.10	0.10%		(I)	
C1608NP0222JHTS	C1608NP0222JHT	1V, 1KHz	2.2	nF	±5%	0.80	+0.15/-0.10	+0.15/-0.10	0.10%		(I)	

□ Tolerance Code: A=±0.05 pF, B=±0.1pF, C=±0.25pF ,D=±0.5pF, G=±2%, J=±5%; Special tolerance on the request.

● C2012NP0 Series (EIA0805)

RV	DARFON P/N	DARFON P/N 2	Measuring Condition	Capacitance		Available Tolerance	Thick. (mm)	Tolerance(mm)		DF (max.)	Standard Packing	Test Spec.
				Value	Unit			L/W	Thick.			
1000V	C2012NP0100JPPSG	C2012NP0100JPP	1V,1MHz	10	pF	±5%	1.25	±0.15/±0.10	±0.20	0.17%	Embossed, 3Kpcs	(I)
	C2012NP0120JPPSG	C2012NP0120JPP	1V,1MHz	12	pF	±5%	1.25	±0.15/±0.10	±0.20	0.16%		(I)
	C2012NP0150JPPSG	C2012NP0150JPP	1V,1MHz	15	pF	±5%	1.25	±0.15/±0.10	±0.20	0.14%		(I)
	C2012NP0180JPPSG	C2012NP0180JPP	1V,1MHz	18	pF	±5%	1.25	±0.15/±0.10	±0.20	0.13%		(I)
	C2012NP0220JPPSG	C2012NP0220JPP	1V,1MHz	22	pF	±5%	1.25	±0.15/±0.10	±0.20	0.12%		(I)
	C2012NP0270JPPSG	C2012NP0270JPP	1V,1MHz	27	pF	±5%	1.25	±0.15/±0.10	±0.20	0.11%		(I)
	C2012NP0330JPPSG	C2012NP0330JPP	1V,1MHz	33	pF	±5%	1.25	±0.15/±0.10	±0.20	0.10%		(I)
	C2012NP0390JPPSG	C2012NP0390JPP	1V,1MHz	39	pF	±5%	1.25	±0.15/±0.10	±0.20	0.10%		(I)
630V	C2012NP0470JPPSG	C2012NP0470JPP	1V,1MHz	47	pF	±5%	1.25	±0.15/±0.10	±0.20	0.10%	(I)	
	C2012NP0560JPPSG	C2012NP0560JPP	1V,1MHz	56	pF	±5%	1.25	±0.15/±0.10	±0.20	0.10%	(I)	
	C2012NP0680JPPSG	C2012NP0680JPP	1V,1MHz	68	pF	±5%	1.25	±0.15/±0.10	±0.20	0.10%	(I)	
	C2012NP0100JMTSC	C2012NP0100JMT	1V,1MHz	10	pF	±5%	0.60	±0.15/±0.10	±0.10	0.17%	Paper, 4Kpcs	(I)
	C2012NP0100JMTSD		1V,1MHz	10	pF	±5%	0.80	±0.15/±0.10	±0.10	0.17%		(I)
	C2012NP0120JMTSC	C2012NP0120JMT	1V,1MHz	12	pF	±5%	0.60	±0.15/±0.10	±0.10	0.16%		(I)
	C2012NP0120JMTSD		1V,1MHz	12	pF	±5%	0.80	±0.15/±0.10	±0.10	0.16%		(I)
	C2012NP0150JMTSC	C2012NP0150JMT	1V,1MHz	15	pF	±5%	0.60	±0.15/±0.10	±0.10	0.14%		(I)
	C2012NP0150JMTSD		1V,1MHz	15	pF	±5%	0.80	±0.15/±0.10	±0.10	0.14%		(I)
	C2012NP0180JMTSC	C2012NP0180JMT	1V,1MHz	18	pF	±5%	0.60	±0.15/±0.10	±0.10	0.13%		(I)
	C2012NP0180JMTSD		1V,1MHz	18	pF	±5%	0.80	±0.15/±0.10	±0.10	0.13%		(I)
	C2012NP0220JMTSC	C2012NP0220JMT	1V,1MHz	22	pF	±5%	0.60	±0.15/±0.10	±0.10	0.12%		(I)
	C2012NP0220JMTSD		1V,1MHz	22	pF	±5%	0.80	±0.15/±0.10	±0.10	0.12%		(I)
	C2012NP0270JMTSC	C2012NP0270JMT	1V,1MHz	27	pF	±5%	0.60	±0.15/±0.10	±0.10	0.11%		(I)
	C2012NP0270JMTSD		1V,1MHz	27	pF	±5%	0.80	±0.15/±0.10	±0.10	0.11%		(I)
	C2012NP0330JMTSC	C2012NP0330JMT	1V,1MHz	33	pF	±5%	0.60	±0.15/±0.10	±0.10	0.10%		(I)
	C2012NP0330JMTSD		1V,1MHz	33	pF	±5%	0.80	±0.15/±0.10	±0.10	0.10%		(I)
	C2012NP0390JMTSC	C2012NP0390JMT	1V,1MHz	39	pF	±5%	0.60	±0.15/±0.10	±0.10	0.10%		(I)
	C2012NP0390JMTSD		1V,1MHz	39	pF	±5%	0.80	±0.15/±0.10	±0.10	0.10%		(I)
	C2012NP0470JMTSC	C2012NP0470JMT	1V,1MHz	47	pF	±5%	0.60	±0.15/±0.10	±0.10	0.10%		(I)
C2012NP0470JMTSD		1V,1MHz	47	pF	±5%	0.80	±0.15/±0.10	±0.10	0.10%	(I)		
C2012NP0560JMTSC	C2012NP0560JMT	1V,1MHz	56	pF	±5%	0.60	±0.15/±0.10	±0.10	0.10%	(I)		
C2012NP0560JMTSD		1V,1MHz	56	pF	±5%	0.80	±0.15/±0.10	±0.10	0.10%	(I)		
C2012NP0680JMTSC	C2012NP0680JMT	1V,1MHz	68	pF	±5%	0.60	±0.15/±0.10	±0.10	0.10%	(I)		
C2012NP0680JMTSD		1V,1MHz	68	pF	±5%	0.80	±0.15/±0.10	±0.10	0.10%	(I)		
C2012NP0820JMTSD		1V,1MHz	82	pF	±5%	0.80	±0.15/±0.10	±0.10	0.10%	(I)		
C2012NP0101JMTSD	C2012NP0101JMT	1V,1MHz	100	pF	±5%	0.80	±0.15/±0.10	±0.10	0.10%	(I)		
C2012NP0121JMTSD		1V,1MHz	120	pF	±5%	0.80	±0.15/±0.10	±0.10	0.10%	(I)		
C2012NP0151JMTSD		1V,1MHz	150	pF	±5%	0.80	±0.15/±0.10	±0.10	0.10%	(I)		
C2012NP0181JMTSD		1V,1MHz	180	pF	±5%	0.80	±0.15/±0.10	±0.10	0.10%	(I)		
C2012NP0221JMP	C2012NP0221JMP	1V,1MHz	220	pF	±5%	1.25	±0.15/±0.10	±0.20	0.10%	Embossed, 3Kpcs	(I)	
C2012NP0471JMP	C2012NP0471JMP	1V,1MHz	470	pF	±5%	1.25	±0.15/±0.10	±0.20	0.10%		(I)	
C2012NP0102JMP	C2012NP0102JMP	1V,1MHz	1.0	nF	±5%	1.25	±0.15/±0.10	±0.20	0.10%		(I)	
500V	C2012NP0100JLTSC	C2012NP0100JLT	1V,1MHz	10	pF	±5%	0.60	±0.15/±0.10	±0.10	0.17%	Paper, 4Kpcs	(I)
	C2012NP0220JLTSC	C2012NP0220JLT	1V,1MHz	22	pF	±5%	0.60	±0.15/±0.10	±0.10	0.12%		(I)
	C2012NP0470JLTSC	C2012NP0470JLT	1V,1MHz	47	pF	±5%	0.60	±0.15/±0.10	±0.10	0.10%		(I)
	C2012NP0101JLTSD	C2012NP0101JLT	1V,1MHz	100	pF	±5%	0.80	±0.15/±0.10	±0.10	0.10%	(I)	
	C2012NP0221JLPSG	C2012NP0221JLP	1V,1MHz	220	pF	±5%	1.25	±0.15/±0.10	±0.20	0.10%	Embossed, 3Kpcs	(I)
	C2012NP0471JLPSG	C2012NP0471JLP	1V,1MHz	470	pF	±5%	1.25	±0.15/±0.10	±0.20	0.10%		(I)
C2012NP0102JLPSG	C2012NP0102JLP	1V,1MHz	1.0	nF	±5%	1.25	±0.15/±0.10	±0.20	0.10%	(I)		

RV	DARFON P/N	DARFON P/N 2	Measuring Condition	Capacitance		Available Tolerance	Thick. (mm)	Tolerance(mm)		DF (max.)	Standard Packing	Test Spec.	
				Value	Unit			L/W	Thick.				
250V	C2012NP0100JKTSC	C2012NP0100JKT	1V,1MHz	10	pF	±5%	0.60	±0.15/±0.10	±0.10	0.17%	Paper, 4Kpcs	(I)	
	C2012NP0100JKTSD		1V,1MHz	10	pF	±5%	0.80	±0.15/±0.10	±0.10	0.17%		(I)	
	C2012NP0120JKTSC	C2012NP0120JKT	1V,1MHz	12	pF	±5%	0.60	±0.15/±0.10	±0.10	0.16%		(I)	
	C2012NP0120JKTSD		1V,1MHz	12	pF	±5%	0.80	±0.15/±0.10	±0.10	0.16%		(I)	
	C2012NP0150JKTSC	C2012NP0150JKT	1V,1MHz	15	pF	±5%	0.60	±0.15/±0.10	±0.10	0.14%		(I)	
	C2012NP0150JKTSD		1V,1MHz	15	pF	±5%	0.80	±0.15/±0.10	±0.10	0.14%		(I)	
	C2012NP0180JKTSC	C2012NP0180JKT	1V,1MHz	18	pF	±5%	0.60	±0.15/±0.10	±0.10	0.13%		(I)	
	C2012NP0180JKTSD		1V,1MHz	18	pF	±5%	0.80	±0.15/±0.10	±0.10	0.13%		(I)	
	C2012NP0220JKTSC	C2012NP0220JKT	1V,1MHz	22	pF	±5%	0.60	±0.15/±0.10	±0.10	0.12%		(I)	
	C2012NP0220JKTSD		1V,1MHz	22	pF	±5%	0.80	±0.15/±0.10	±0.10	0.12%		(I)	
	C2012NP0270JKTSC	C2012NP0270JKT	1V,1MHz	27	pF	±5%	0.60	±0.15/±0.10	±0.10	0.11%		(I)	
	C2012NP0270JKTSD		1V,1MHz	27	pF	±5%	0.80	±0.15/±0.10	±0.10	0.11%		(I)	
	C2012NP0330JKTSC	C2012NP0330JKT	1V,1MHz	33	pF	±5%	0.60	±0.15/±0.10	±0.10	0.10%		(I)	
	C2012NP0330JKTSD		1V,1MHz	33	pF	±5%	0.80	±0.15/±0.10	±0.10	0.10%		(I)	
	C2012NP0390JKTSC	C2012NP0390JKT	1V,1MHz	39	pF	±5%	0.60	±0.15/±0.10	±0.10	0.10%		(I)	
	C2012NP0390JKTSD		1V,1MHz	39	pF	±5%	0.80	±0.15/±0.10	±0.10	0.10%		(I)	
	C2012NP0470JKTSC	C2012NP0470JKT	1V,1MHz	47	pF	±5%	0.60	±0.15/±0.10	±0.10	0.10%		(I)	
	C2012NP0470JKTSD		1V,1MHz	47	pF	±5%	0.80	±0.15/±0.10	±0.10	0.10%		(I)	
	C2012NP0560JKTSC	C2012NP0560JKT	1V,1MHz	56	pF	±5%	0.60	±0.15/±0.10	±0.10	0.10%		(I)	
	C2012NP0560JKTSD		1V,1MHz	56	pF	±5%	0.80	±0.15/±0.10	±0.10	0.10%		(I)	
	C2012NP0680JKTSC	C2012NP0680JKT	1V,1MHz	68	pF	±5%	0.60	±0.15/±0.10	±0.10	0.10%		(I)	
	C2012NP0680JKTSD		1V,1MHz	68	pF	±5%	0.80	±0.15/±0.10	±0.10	0.10%		(I)	
	C2012NP0820JKTSC	C2012NP0820JKT	1V,1MHz	82	pF	±5%	0.60	±0.15/±0.10	±0.10	0.10%		(I)	
	C2012NP0820JKTSD		1V,1MHz	82	pF	±5%	0.80	±0.15/±0.10	±0.10	0.10%		(I)	
	C2012NP0101JKTSD	C2012NP0101JKT	1V,1MHz	100	pF	±5%	0.80	±0.15/±0.10	±0.10	0.10%		(I)	
	C2012NP0121JKTSD	C2012NP0121JKT	1V,1MHz	120	pF	±5%	0.80	±0.15/±0.10	±0.10	0.10%		(I)	
	C2012NP0151JKTSD		1V,1MHz	150	pF	±5%	0.80	±0.15/±0.10	±0.20	0.10%		(I)	
	C2012NP0151JKPSG	C2012NP0151JKP	1V,1MHz	150	pF	±5%	1.25	±0.15/±0.10	±0.20	0.10%		Embossed, 3Kpcs	(I)
	C2012NP0181JKTSD		1V,1MHz	180	pF	±5%	0.80	±0.15/±0.10	±0.10	0.10%		Paper, 4Kpcs	(I)
	C2012NP0221JKTSD	C2012NP0221JKT	1V,1MHz	220	pF	±5%	0.80	±0.15/±0.10	±0.10	0.10%		Paper, 4Kpcs	(I)
	C2012NP0221JKPSG	C2012NP0221JKP	1V,1MHz	220	pF	±5%	1.25	±0.15/±0.10	±0.20	0.10%		Embossed, 3Kpcs	(I)
	C2012NP0271JKTSD		1V,1MHz	270	pF	±5%	0.80	±0.15/±0.10	±0.20	0.10%		Paper, 4Kpcs	(I)
	C2012NP0271JKPSG	C2012NP0271JKP	1V,1MHz	270	pF	±5%	1.25	±0.15/±0.10	±0.20	0.10%		Embossed, 3Kpcs	(I)
	C2012NP0331JKTSD		1V,1MHz	330	pF	±5%	0.80	±0.15/±0.10	±0.20	0.10%		Paper, 4Kpcs	(I)
	C2012NP0331JKPSG	C2012NP0331JKP	1V,1MHz	330	pF	±5%	1.25	±0.15/±0.10	±0.20	0.10%		Embossed, 3Kpcs	(I)
	C2012NP0471JKTSD		1V,1MHz	470	pF	±5%	0.80	±0.15/±0.10	±0.20	0.10%		Paper, 4Kpcs	(I)
C2012NP0471JKPSG	C2012NP0471JKP	1V,1MHz	470	pF	±5%	1.25	±0.15/±0.10	±0.20	0.10%	Embossed, 3Kpcs	(I)		
C2012NP0561JKTSD		1V,1MHz	560	pF	±5%	0.80	±0.15/±0.10	±0.20	0.10%	Paper, 4Kpcs	(I)		
C2012NP0561JKPSG	C2012NP0561JKP	1V,1MHz	560	pF	±5%	1.25	±0.15/±0.10	±0.20	0.10%	Embossed, 3Kpcs	(I)		
C2012NP0102JKTSD	C2012NP0102JKT	1V,1MHz	1.0	nF	±5%	0.80	±0.15/±0.10	±0.20	0.10%	Paper, 4Kpcs	(I)		
C2012NP0222JKTSD	C2012NP0222JKP	1V, 1kHz	2.2	nF	±5%	1.25	±0.15/±0.10	±0.20	0.10%	Paper, 4Kpcs	(I)		
C2012NP0392JKTSD	C2012NP0392JKP	1V, 1kHz	3.9	nF	±5%	1.25	±0.15/±0.10	±0.20	0.10%	Embossed, 3Kpcs	(I)		
C2012NP0472JKTSD	C2012NP0472JKP	1V, 1kHz	4.7	nF	±5%	1.25	±0.15/±0.10	±0.20	0.10%	Embossed, 3Kpcs	(I)		
200V	C2012NP0220JJTSC	C2012NP0220JJT	1V,1MHz	22	pF	±5%	0.60	±0.15/±0.10	±0.10	0.12%	Paper, 4Kpcs	(I)	
	C2012NP0270JJTSC	C2012NP0270JJT	1V,1MHz	27	pF	±5%	0.60	±0.15/±0.10	±0.10	0.11%		(I)	
	C2012NP0221JJTSD	C2012NP0221JJT	1V,1MHz	220	pF	±5%	0.80	±0.15/±0.10	±0.10	0.10%		(I)	
	C2012NP0331JJTSD	C2012NP0331JJT	1V,1MHz	330	pF	±5%	0.80	±0.15/±0.10	±0.20	0.10%		(I)	
	C2012NP0471JJPSG	C2012NP0471JJP	1V,1MHz	470	pF	±5%	1.25	±0.15/±0.10	±0.20	0.10%		Embossed, 3Kpcs	(I)
	C2012NP0392JJPSG	C2012NP0392JJP	1V, 1kHz	3.9	nF	±5%	1.25	±0.15/±0.10	±0.20	0.10%		Embossed, 3Kpcs	(I)
100V	C2012NP0479CHTSC	C2012NP0479CHT	1V, 1MHz	4.7	pF	±0.25pF	0.60	±0.15/±0.10	±0.10	0.20%	Paper, 4Kpcs	(I)	
	C2012NP0100JHTSC	C2012NP0100JHT	1V, 1MHz	10	pF	±5%	0.60	±0.15/±0.10	±0.10	0.17%		(I)	
	C2012NP0100JHTSD		1V, 1MHz	10	pF	±5%	0.80	±0.15/±0.10	±0.10	0.17%		(I)	
	C2012NP0120□HTSC	C2012NP0120□HT	1V, 1MHz	12	pF	±5%, ±2%, ±1%	0.60	±0.15/±0.10	±0.10	0.16%		(I)	
	C2012NP0120JHTSD		1V, 1MHz	12	pF	±5%	0.80	±0.15/±0.10	±0.10	0.16%		(I)	
	C2012NP0150JHTSC	C2012NP0150JHT	1V, 1MHz	15	pF	±5%	0.60	±0.15/±0.10	±0.10	0.14%		(I)	
	C2012NP0150JHTSD		1V, 1MHz	15	pF	±5%	0.80	±0.15/±0.10	±0.10	0.14%		(I)	
	C2012NP0180JHTSC	C2012NP0180JHT	1V, 1MHz	18	pF	±5%	0.60	±0.15/±0.10	±0.10	0.13%		(I)	
	C2012NP0180JHTSD		1V, 1MHz	18	pF	±5%	0.80	±0.15/±0.10	±0.10	0.13%		(I)	
	C2012NP0200JHTSC	C2012NP0200JHT	1V, 1MHz	20	pF	±5%	0.60	±0.15/±0.10	±0.10	0.13%		(I)	
	C2012NP0200JHTSD		1V, 1MHz	20	pF	±5%	0.80	±0.15/±0.10	±0.10	0.13%		(I)	
	C2012NP0220JHTSC	C2012NP0220JHT	1V, 1MHz	22	pF	±5%	0.60	±0.15/±0.10	±0.10	0.12%		(I)	
	C2012NP0220JHTSD		1V, 1MHz	22	pF	±5%	0.80	±0.15/±0.10	±0.10	0.12%		(I)	
	C2012NP0240JHTSC	C2012NP0240JHT	1V, 1MHz	24	pF	±5%	0.60	±0.15/±0.10	±0.10	0.11%		(I)	
	C2012NP0240JHTSD		1V, 1MHz	24	pF	±5%	0.80	±0.15/±0.10	±0.10	0.11%		(I)	
	C2012NP0270JHTSC	C2012NP0270JHT	1V, 1MHz	27	pF	±5%	0.60	±0.15/±0.10	±0.10	0.11%		(I)	
	C2012NP0270JHTSD		1V, 1MHz	27	pF	±5%	0.80	±0.15/±0.10	±0.10	0.11%		(I)	
	C2012NP0300JHTSC	C2012NP0300JHT	1V, 1MHz	30	pF	±5%	0.60	±0.15/±0.10	±0.10	0.10%		(I)	
	C2012NP0300JHTSD		1V, 1MHz	30	pF	±5%	0.80	±0.15/±0.10	±0.10	0.10%		(I)	
	C2012NP0330JHTSC	C2012NP0330JHT	1V, 1MHz	33	pF	±5%	0.60	±0.15/±0.10	±0.10	0.10%		(I)	
	C2012NP0330JHTSD		1V, 1MHz	33	pF	±5%	0.80	±0.15/±0.10	±0.10	0.10%		(I)	
	C2012NP0360JHTSC	C2012NP0360JHT	1V, 1MHz	36	pF	±5%	0.60	±0.15/±0.10	±0.10	0.10%		(I)	
	C2012NP0360JHTSD		1V, 1MHz	36	pF	±5%	0.80	±0.15/±0.10	±0.10	0.10%		(I)	
	C2012NP0390JHTSC	C2012NP0390JHT	1V, 1MHz	39	pF	±5%	0.60	±0.15/±0.10	±0.10	0.10%		(I)	
	C2012NP0390JHTSD		1V, 1MHz	39	pF	±5%	0.80	±0.15/±0.10	±0.10	0.10%		(I)	
	C2012NP0430JHTSC	C2012NP0430JHT	1V, 1MHz	43	pF	±5%	0.60	±0.15/±0.10	±0.10	0.10%		(I)	
	C2012NP0430JHTSD		1V, 1MHz	43	pF	±5%	0.80	±0.15/±0.10	±0.10	0.10%		(I)	
	C2012NP0470JHTSC	C2012NP0470JHT	1V, 1MHz	47	pF	±5%	0.60	±0.15/±0.10	±0.10	0.10%		(I)	
	C2012NP0470JHTSD		1V, 1MHz	47	pF	±5%	0.80	±0.15/±0.10	±0.10	0.10%		(I)	
	C2012NP0560JHTSC	C2012NP0560JHT	1V, 1MHz	56	pF	±5%	0.60	±0.15/±0.10	±0.10	0.10%		(I)	
	C2012NP0560JHTSD		1V, 1MHz	56	pF	±5%	0.80	±0.15/±0.10	±0.10	0.10%		(I)	
	C2012NP0620JHTSC	C2012NP0620JHT	1V, 1MHz	62	pF	±5%	0.60	±0.15/±0.10	±0.10	0.10%		(I)	
	C2012NP0620JHTSD		1V, 1MHz	62	pF	±5%	0.80	±0.15/±0.10	±0.10	0.10%		(I)	

MLCC
Middle High Voltage

RV	DARFON P/N	DARFON P/N 2	Measuring Condition	Capacitance		Available Tolerance	Thick. (mm)	Tolerance(mm)		DF (max.)	Standard Packing	Test Spec.
				Value	Unit			L/W	Thick.			
100V	C2012NP0680JHTSC	C2012NP0680JHT	1V, 1MHz	68	pF	±5%	0.60	±0.15/±0.10	±0.10	0.10%	Paper, 4Kpcs	(I)
	C2012NP0680JHTSD		1V, 1MHz	68	pF	±5%	0.80	±0.15/±0.10	±0.10	0.10%		(I)
	C2012NP0750JHTSC	C2012NP0750JHT	1V, 1MHz	75	pF	±5%	0.60	±0.15/±0.10	±0.10	0.10%		(I)
	C2012NP0750JHTSD		1V, 1MHz	75	pF	±5%	0.80	±0.15/±0.10	±0.10	0.10%		(I)
	C2012NP0820JHTSC	C2012NP0820JHT	1V, 1MHz	82	pF	±5%	0.60	±0.15/±0.10	±0.10	0.10%		(I)
	C2012NP0820JHTSD		1V, 1MHz	82	pF	±5%	0.80	±0.15/±0.10	±0.10	0.10%		(I)
	C2012NP0101JHTSC	C2012NP0101JHT	1V, 1MHz	100	pF	±5%	0.60	±0.15/±0.10	±0.10	0.10%		(I)
	C2012NP0101JHTSD		1V, 1MHz	100	pF	±5%	0.80	±0.15/±0.10	±0.10	0.10%		(I)
	C2012NP0121JHTSC	C2012NP0121JHT	1V, 1MHz	120	pF	±5%	0.60	±0.15/±0.10	±0.10	0.10%		(I)
	C2012NP0121JHTSD		1V, 1MHz	120	pF	±5%	0.80	±0.15/±0.10	±0.10	0.10%		(I)
	C2012NP0131JHTSC	C2012NP0131JHT	1V, 1MHz	130	pF	±5%	0.60	±0.15/±0.10	±0.10	0.10%		(I)
	C2012NP0151JHTSC	C2012NP0151JHT	1V, 1MHz	150	pF	±5%	0.60	±0.15/±0.10	±0.10	0.10%		(I)
	C2012NP0151JHTSD		1V, 1MHz	150	pF	±5%	0.80	±0.15/±0.10	±0.10	0.10%		(I)
	C2012NP0181JHTSC	C2012NP0181JHT	1V, 1MHz	180	pF	±5%	0.60	±0.15/±0.10	±0.10	0.10%		(I)
	C2012NP0181JHTSD		1V, 1MHz	180	pF	±5%	0.80	±0.15/±0.10	±0.10	0.10%		(I)
	C2012NP0201JHTSC	C2012NP0201JHT	1V, 1MHz	200	pF	±5%	0.60	±0.15/±0.10	±0.10	0.10%		(I)
	C2012NP0201JHTSD		1V, 1MHz	200	pF	±5%	0.80	±0.15/±0.10	±0.10	0.10%		(I)
	C2012NP0221JHTSC	C2012NP0221JHT	1V, 1MHz	220	pF	±5%	0.60	±0.15/±0.10	±0.10	0.10%		(I)
	C2012NP0221JHTSD		1V, 1MHz	220	pF	±5%	0.80	±0.15/±0.10	±0.10	0.10%		(I)
	C2012NP0271JHTSC	C2012NP0271JHT	1V, 1MHz	270	pF	±5%	0.60	±0.15/±0.10	±0.10	0.10%		(I)
	C2012NP0271JHTSD		1V, 1MHz	270	pF	±5%	0.80	±0.15/±0.10	±0.10	0.10%		(I)
	C2012NP0331JHTSC	C2012NP0331JHT	1V, 1MHz	330	pF	±5%	0.60	±0.15/±0.10	±0.10	0.10%		(I)
	C2012NP0331JHTSD		1V, 1MHz	330	pF	±5%	0.80	±0.15/±0.10	±0.10	0.10%		(I)
	C2012NP0391JHTSD	C2012NP0391JHT	1V, 1MHz	390	pF	±5%	0.80	±0.15/±0.10	±0.10	0.10%		(I)
	C2012NP0471JHTSD	C2012NP0471JHT	1V, 1MHz	470	pF	±5%	0.80	±0.15/±0.10	±0.10	0.10%		(I)
	C2012NP0561JHTSD	C2012NP0561JHT	1V, 1MHz	560	pF	±5%	0.80	±0.15/±0.10	±0.10	0.10%		(I)
	C2012NP0681JHTSD	C2012NP0681JHT	1V, 1MHz	680	pF	±5%	0.80	±0.15/±0.10	±0.10	0.10%		(I)
	C2012NP0821JHTSD	C2012NP0821JHT	1V, 1MHz	820	pF	±5%	0.80	±0.15/±0.10	±0.10	0.10%		(I)
	C2012NP0102JHTSD	C2012NP0102JHT	1V, 1MHz	1.0	nF	±5%	0.80	±0.15/±0.10	±0.10	0.10%	(I)	
	C2012NP0122JHTSD	C2012NP0122JHT	1V, 1kHz	1.2	nF	±5%	0.80	±0.15/±0.10	±0.10	0.10%	(I)	
C2012NP0152JHTSD	C2012NP0152JHT	1V, 1kHz	1.5	nF	±5%	0.80	±0.15/±0.10	±0.10	0.10%	(I)		
C2012NP0182JHTSD	C2012NP0182JHT	1V, 1kHz	1.8	nF	±5%	0.80	±0.15/±0.10	±0.10	0.10%	(I)		
C2012NP0222JHTSD	C2012NP0222JHT	1V, 1kHz	2.2	nF	±5%	0.80	±0.15/±0.10	±0.10	0.10%	(I)		
C2012NP0272JHP	C2012NP0272JHP	1V, 1kHz	2.7	nF	±5%	1.25	±0.15/±0.10	±0.20	0.10%	Embossed, 3Kpcs	(I)	
C2012NP0332JHP	C2012NP0332JHP	1V, 1kHz	3.3	nF	±5%	1.25	±0.15/±0.10	±0.20	0.10%		(I)	

● C3216NP0 Series (EIA1206)

RV	DARFON P/N	DARFON P/N 2	Measuring Condition	Capacitance		Available Tolerance	Thick. (mm)	Tolerance(mm)		DF (max.)	Standard Packing	Test Spec.
				Value	Unit			L/W	Thick.			
2000V	C3216NP0339CQTS	C3216NP0339CQT	1V, 1MHz	3.3	pF	±0.25pF	0.80	±0.15	±0.10	0.21%	Paper, 4Kpcs	(I)
	C3216NP0100JQTS	C3216NP0100JQT	1V, 1MHz	10	pF	±5%	0.80	±0.15	±0.10	0.17%		(I)
	C3216NP0220JQTS	C3216NP0220JQT	1V, 1MHz	22	pF	±5%	0.80	±0.15	±0.10	0.12%		(I)
	C3216NP0270JQPSG	C3216NP0270JQP	1V, 1MHz	27	pF	±5%	1.25	±0.15	±0.10	0.11%	Embossed, 3Kpcs	(I)
	C3216NP0330JQPSG	C3216NP0330JQP	1V, 1MHz	33	pF	±5%	1.25	±0.15	±0.10	0.10%		(I)
	C3216NP0470JQPSG	C3216NP0470JQP	1V, 1MHz	47	pF	±5%	1.25	±0.15	±0.10	0.10%	Embossed, 3Kpcs	(I)
	C3216NP0680JQPSG	C3216NP0680JQP	1V, 1MHz	68	pF	±5%	1.25	±0.15	±0.10	0.10%		(I)
	C3216NP0101JQPSG	C3216NP0101JQP	1V, 1MHz	100	pF	±5%	1.25	±0.15	±0.10	0.10%		(I)
	C3216NP0221JQPSL	C3216NP0221JQP	1V, 1MHz	220	pF	±5%	1.60	±0.20	±0.20	0.10%		Embossed, 2Kpcs

RV	DARFON P/N	DARFON P/N 2	Measuring Condition	Capacitance		Available Tolerance	Thick. (mm)	Tolerance(mm)		DF (max.)	Standard Packing	Test Spec.	
				Value	Unit			L/W	Thick.				
1000V	C3216NP0100JPTSD	C3216NP0100JPT	1V,1MHz	10	pF	±5%	0.80	±0.15	±0.10	0.17%	Paper, 4Kpcs	(I)	
	C3216NP0120JPTSD	C3216NP0120JPT	1V,1MHz	12	pF	±5%	0.80	±0.15	±0.10	0.16%		(I)	
	C3216NP0150JPTSD	C3216NP0150JPT	1V,1MHz	15	pF	±5%	0.80	±0.15	±0.10	0.14%		(I)	
	C3216NP0180JPTSD	C3216NP0180JPT	1V,1MHz	18	pF	±5%	0.80	±0.15	±0.10	0.13%		(I)	
	C3216NP0220□PTSD	C3216NP0220□PT	1V,1MHz	22	pF	±10%,±5%	0.80	±0.15	±0.10	0.12%	(I)	Embossed,3Kpcs	(I)
	C3216NP0220JPPSG	C3216NP0220JPP	1V,1MHz	22	pF	±5%	1.25	±0.15	±0.10	0.12%	(I)		
	C3216NP0270JPTSD	C3216NP0270JPT	1V,1MHz	27	pF	±5%	0.80	±0.15	±0.10	0.11%	Paper, 4Kpcs	(I)	
	C3216NP0270JPPSG	C3216NP0270JPP	1V,1MHz	27	pF	±5%	1.25	±0.15	±0.10	0.11%	Embossed,3Kpcs	(I)	
	C3216NP0330JPTSD	C3216NP0330JPT	1V,1MHz	33	pF	±5%	0.80	±0.15	±0.10	0.10%	Paper, 4Kpcs	(I)	
	C3216NP0330JPPSG	C3216NP0330JPP	1V,1MHz	33	pF	±5%	1.25	±0.15	±0.10	0.10%	Embossed,3Kpcs	(I)	
	C3216NP0390JPTSD	C3216NP0390JPT	1V,1MHz	39	pF	±5%	0.80	±0.15	±0.10	0.10%	Paper, 4Kpcs	(I)	
	C3216NP0470JPTSD	C3216NP0470JPT	1V,1MHz	47	pF	±5%	0.80	±0.15	±0.10	0.10%	Paper, 4Kpcs	(I)	
	C3216NP0470JPPSG	C3216NP0470JPP	1V,1MHz	47	pF	±5%	1.25	±0.15	±0.20	0.10%	Embossed,3Kpcs	(I)	
	C3216NP0560JPTSD	C3216NP0560JPT	1V,1MHz	56	pF	±5%	0.80	±0.15	±0.10	0.10%	Paper, 4Kpcs	(I)	
	C3216NP0680JPTSD	C3216NP0680JPT	1V,1MHz	68	pF	±5%	0.80	±0.15	±0.10	0.10%	Paper, 4Kpcs	(I)	
	C3216NP0680JPPSG	C3216NP0680JPP	1V,1MHz	68	pF	±5%	1.25	±0.15	±0.20	0.10%	Embossed,3Kpcs	(I)	
	C3216NP0820JPTSD	C3216NP0820JPT	1V,1MHz	82	pF	±5%	0.80	±0.15	±0.10	0.10%	Paper, 4Kpcs	(I)	
	C3216NP0820JPPSG	C3216NP0820JPP	1V,1MHz	82	pF	±5%	1.25	±0.15	±0.20	0.10%	Embossed,3Kpcs	(I)	
	C3216NP0101JPPSG	C3216NP0101JPP	1V,1MHz	100	pF	±5%	1.25	±0.15	±0.20	0.10%	(I)	Embossed,2Kpcs	(I)
	C3216NP0101JPWGS	C3216NP0101JPW	1V,1MHz	100	pF	±5%	1.25	±0.15	±0.20	0.10%	(I)		
	C3216NP0121JPPSG	C3216NP0121JPP	1V,1MHz	120	pF	±5%	1.25	±0.15	±0.20	0.10%	(I)	Embossed,3Kpcs	(I)
	C3216NP0151JPPSG	C3216NP0151JPP	1V,1MHz	150	pF	±5%	1.25	±0.15	±0.20	0.10%	(I)		
	C3216NP0181JPPSL	C3216NP0181JPP	1V,1MHz	180	pF	±5%	1.60	±0.15	±0.20	0.10%	(I)	Embossed,2Kpcs	(I)
	C3216NP0221□PPSL	C3216NP0221□PP	1V,1MHz	220	pF	±10%,±5%	1.60	±0.15	±0.20	0.10%	(I)		
	C3216NP0271JPPSL	C3216NP0271JPP	1V,1MHz	270	pF	±5%	1.60	±0.20	±0.20	0.10%	(I)		
	C3216NP0331JPPSL	C3216NP0331JPP	1V,1MHz	330	pF	±5%	1.60	±0.20	±0.20	0.10%	(I)		
	C3216NP0391JPPSL	C3216NP0391JPP	1V,1MHz	390	pF	±5%	1.60	±0.20	±0.20	0.10%	(I)		
	C3216NP0471□PPSL	C3216NP0471□PP	1V,1MHz	470	pF	±10%,±5%	1.60	±0.20	±0.20	0.10%	(I)		
	C3216NP0561JPPSL	C3216NP0561JPP	1V,1MHz	560	pF	±5%	1.60	±0.20	±0.20	0.10%	(I)	Embossed,3Kpcs	(I)
	C3216NP0102JPPSL	C3216NP0102JPP	1V,1MHz	1.0	nF	±5%	1.60	±0.20	±0.20	0.10%	(I)		
630V	C3216NP0100JMTSD	C3216NP0100JMT	1V,1MHz	10	pF	±5%	0.80	±0.15	±0.10	0.17%	Paper,4Kpcs	(I)	
	C3216NP0150JMTSD	C3216NP0150JMT	1V,1MHz	15	pF	±5%	0.80	±0.15	±0.10	0.14%		(I)	
	C3216NP0220JMTSD	C3216NP0220JMT	1V,1MHz	22	pF	±5%	0.80	±0.15	±0.10	0.12%		(I)	
	C3216NP0270JMTSD	C3216NP0270JMT	1V,1MHz	27	pF	±5%	0.80	±0.15	±0.10	0.11%		(I)	
	C3216NP0270JMPSG	C3216NP0270JMP	1V,1MHz	27	pF	±5%	1.25	±0.15	±0.10	0.11%	Embossed,3Kpcs	(I)	
	C3216NP0330JMTSD	C3216NP0330JMT	1V,1MHz	33	pF	±5%	0.80	±0.15	±0.10	0.10%	Paper,4Kpcs	(I)	
	C3216NP0330JMPSG	C3216NP0330JMP	1V,1MHz	33	pF	±5%	1.25	±0.15	±0.10	0.10%	Embossed,3Kpcs	(I)	
	C3216NP0470JMTSD	C3216NP0470JMT	1V,1MHz	47	pF	±5%	0.80	±0.15	±0.10	0.10%	Embossed,3Kpcs	(I)	
	C3216NP0560JMTSD	C3216NP0560JMT	1V,1MHz	56	pF	±5%	0.80	±0.15	±0.10	0.10%		(I)	
	C3216NP0680JMTSD	C3216NP0680JMT	1V,1MHz	68	pF	±5%	0.80	±0.15	±0.10	0.10%		(I)	
	C3216NP0820JMTSD	C3216NP0820JMT	1V,1MHz	82	pF	±5%	0.80	±0.15	±0.10	0.10%		(I)	
	C3216NP0101JMTSD	C3216NP0101JMT	1V,1MHz	100	pF	±5%	0.80	±0.15	±0.10	0.10%		Paper,4Kpcs	(I)
	C3216NP0121JMTSD	C3216NP0121JMT	1V,1MHz	120	pF	±5%	0.80	±0.15	±0.10	0.10%			(I)
	C3216NP0151JMTSD	C3216NP0151JMT	1V,1MHz	150	pF	±5%	0.80	±0.15	±0.10	0.10%	(I)	Embossed,3Kpcs	(I)
	C3216NP0181JMTSD	C3216NP0181JMT	1V,1MHz	180	pF	±5%	0.80	±0.15	±0.10	0.10%	(I)		
	C3216NP0221JMTSD	C3216NP0221JMT	1V,1MHz	220	pF	±5%	0.80	±0.15	±0.10	0.10%	(I)	Embossed,3Kpcs	(I)
	C3216NP0271JMTSD	C3216NP0271JMT	1V,1MHz	270	pF	±5%	0.80	±0.15	±0.10	0.10%	(I)		
	C3216NP0271JMPSI	C3216NP0271JMP	1V,1MHz	270	pF	±5%	0.95	±0.15	±0.10	0.10%	Embossed,3Kpcs	(I)	
	C3216NP0331JMTSD	C3216NP0331JMT	1V,1MHz	330	pF	±5%	0.80	±0.15	±0.10	0.10%	Paper,4Kpcs	(I)	
	C3216NP0331JMPSI	C3216NP0331JMP	1V,1MHz	330	pF	±5%	0.95	±0.15	±0.10	0.10%	Embossed,3Kpcs	(I)	
	C3216NP0391JMTSD	C3216NP0391JMT	1V,1MHz	390	pF	±5%	0.80	±0.15	±0.10	0.10%	Paper,4Kpcs	(I)	
	C3216NP0391JMPSI	C3216NP0391JMP	1V,1MHz	390	pF	±5%	0.95	±0.15	±0.10	0.10%	Embossed,3Kpcs	(I)	
	C3216NP0471JMTSD	C3216NP0471JMT	1V,1MHz	470	pF	±5%	0.80	±0.15	±0.10	0.10%	Paper,4Kpcs	(I)	
	C3216NP0471JMPSI	C3216NP0471JMP	1V,1MHz	470	pF	±5%	0.95	±0.15	±0.10	0.10%	Embossed,3Kpcs	(I)	
	C3216NP0681JMPSL	C3216NP0681JMP	1V,1MHz	680	pF	±5%	1.60	±0.30/±0.20	±0.20	0.10%	(I)	Embossed,2Kpcs	(I)
	C3216NP0102JMPSL	C3216NP0102JMP	1V,1MHz	1.0	nF	±5%	1.60	±0.30/±0.20	±0.20	0.10%	(I)		
	C3216NP0222JMPSL	C3216NP0222JMP	1V,1kHz	2.2	nF	±5%	1.60	±0.30/±0.20	±0.20	0.10%	(I)	(I)	

□ Tolerance Code: A=±0.05 pF, B=±0.1pF, C=±0.25pF, D=±0.5pF, G=±2%, J=±5%; Special tolerance on the request.

RV	DARFON P/N	DARFON P/N 2	Measuring Condition	Capacitance Value	Unit	Available Tolerance	Thick. (mm)	Tolerance(mm)		DF (max.)	Standard Packing	Test Spec.
								L/W	Thick.			
500V	C3216NP0100JLTSD	C3216NP0100JLT	1V,1MHz	10	pF	±5%	0.80	±0.15	±0.10	0.17%	Paper, 4Kpcs	(I)
	C3216NP0220JLTSD	C3216NP0220JLT	1V,1MHz	22	pF	±5%	0.80	±0.15	±0.10	0.12%		(II)
	C3216NP0270JLTSD	C3216NP0270JLT	1V,1MHz	27	pF	±5%	0.80	±0.15	±0.10	0.11%		(I)
	C3216NP0470JLTSD	C3216NP0470JLT	1V,1MHz	47	pF	±5%	0.80	±0.15	±0.10	0.10%		(I)
	C3216NP0101JLTSD	C3216NP0101JLT	1V,1MHz	100	pF	±5%	0.80	±0.15	±0.10	0.10%		(I)
	C3216NP0221JLTSD	C3216NP0221JLT	1V,1MHz	220	pF	±5%	0.80	±0.15	±0.10	0.10%		(I)
	C3216NP0471JLTSD	C3216NP0471JLT	1V,1MHz	470	pF	±5%	0.80	±0.15	±0.10	0.10%		Paper, 4Kpcs
	C3216NP0471JLPSI	C3216NP0471JLP	1V,1MHz	470	pF	±5%	0.95	±0.15	±0.10	0.10%		Embossed,3Kpcs
	C3216NP0102JLPSL	C3216NP0102JLP	1V,1MHz	1.0	nF	±5%	1.60	±0.30/±0.20	±0.20	0.10%		Embossed,2Kpcs
C3216NP0222JLPSL	C3216NP0222JLP	1V,1kHz	2.2	nF	±5%	1.60	±0.30/±0.20	±0.20	0.10%	(I)		
250V	C3216NP0121JKTSD	C3216NP0121JKT	1V,1MHz	120	pF	±5%	0.80	±0.15	±0.10	0.10%	Paper,4Kpcs	(I)
	C3216NP0151JKTSD	C3216NP0151JKT	1V,1MHz	150	pF	±5%	0.80	±0.15	±0.10	0.10%		(II)
	C3216NP0181JKTSD	C3216NP0181JKT	1V,1MHz	180	pF	±5%	0.80	±0.15	±0.10	0.10%		(I)
	C3216NP0221JKTSD	C3216NP0221JKT	1V,1MHz	220	pF	±5%	0.80	±0.15	±0.10	0.10%		(I)
	C3216NP0271JKTSD	C3216NP0271JKT	1V,1MHz	270	pF	±5%	0.80	±0.15	±0.10	0.10%		(I)
	C3216NP0271JKPSI	C3216NP0271JKP	1V,1MHz	270	pF	±5%	0.95	±0.15	±0.10	0.10%		Embossed,3Kpcs
	C3216NP0331JKTSD	C3216NP0331JKT	1V,1MHz	330	pF	±5%	0.80	±0.15	±0.10	0.10%		Paper, 4Kpcs
	C3216NP0331JKPSI	C3216NP0331JKP	1V,1MHz	330	pF	±5%	0.95	±0.15	±0.10	0.10%		Embossed,3Kpcs
	C3216NP0391JKTSD	C3216NP0391JKT	1V,1MHz	390	pF	±5%	0.80	±0.15	±0.10	0.10%		Paper, 4Kpcs
	C3216NP0391JKPSI	C3216NP0391JKP	1V,1MHz	390	pF	±5%	0.95	±0.15	±0.10	0.10%		Embossed,3Kpcs
	C3216NP0471JKTSD	C3216NP0471JKT	1V,1MHz	470	pF	±5%	0.80	±0.15	±0.10	0.10%		Paper, 4Kpcs
	C3216NP0471JKPSI	C3216NP0471JKP	1V,1MHz	470	pF	±5%	0.95	±0.15	±0.10	0.10%		Embossed,3Kpcs
	C3216NP0102JKPSL	C3216NP0102JKP	1V,1MHz	1.0	nF	±5%	1.60	±0.30/±0.20	±0.20	0.10%		Embossed,2Kpcs
200V	C3216NP0101JUTSD	C3216NP0101JUT	1V,1MHz	100	pF	±5%	0.80	±0.15	±0.10	0.10%	Paper, 4Kpcs	(I)
	C3216NP0221JUTSD	C3216NP0221JUT	1V,1MHz	220	pF	±5%	0.80	±0.15	±0.10	0.10%		(II)
	C3216NP0102JUPS	C3216NP0102JUP	1V, 1MHz	1.0	nF	±5%	0.95	±0.15	±0.10	0.10%		Embossed,3Kpcs
	C3216NP0102JUPS	C3216NP0102JUP	1V, 1MHz	1.0	nF	±5%	1.60	±0.30/±0.20	±0.20	0.10%		Embossed,2Kpcs
100V	C3216NP0100JHTSD	C3216NP0100JHT	1V, 1MHz	10	pF	±5%	0.80	±0.15	±0.10	0.17%	Paper,4Kpcs	(I)
	C3216NP0120JHTSD	C3216NP0120JHT	1V, 1MHz	12	pF	±5%	0.80	±0.15	±0.10	0.16%		(II)
	C3216NP0150JHTSD	C3216NP0150JHT	1V, 1MHz	15	pF	±5%	0.80	±0.15	±0.10	0.14%		(I)
	C3216NP0180JHTSD	C3216NP0180JHT	1V, 1MHz	18	pF	±5%	0.80	±0.15	±0.10	0.13%		(I)
	C3216NP0220JHTSD	C3216NP0220JHT	1V, 1MHz	22	pF	±5%	0.80	±0.15	±0.10	0.12%		(I)
	C3216NP0270JHTSD	C3216NP0270JHT	1V, 1MHz	27	pF	±5%	0.80	±0.15	±0.10	0.11%		(I)
	C3216NP0330JHTSD	C3216NP0330JHT	1V, 1MHz	33	pF	±5%	0.80	±0.15	±0.10	0.10%		(I)
	C3216NP0390JHTSD	C3216NP0390JHT	1V, 1MHz	39	pF	±5%	0.80	±0.15	±0.10	0.10%		(I)
	C3216NP0470JHTSD	C3216NP0470JHT	1V, 1MHz	47	pF	±5%	0.80	±0.15	±0.10	0.10%		(I)
	C3216NP0560JHTSD	C3216NP0560JHT	1V, 1MHz	56	pF	±5%	0.80	±0.15	±0.10	0.10%		(I)
	C3216NP0680JHTSD	C3216NP0680JHT	1V, 1MHz	68	pF	±5%	0.80	±0.15	±0.10	0.10%		(I)
	C3216NP0820JHTSD	C3216NP0820JHT	1V, 1MHz	82	pF	±5%	0.80	±0.15	±0.10	0.10%		(I)
	C3216NP0101JHTSD	C3216NP0101JHT	1V, 1MHz	100	pF	±5%	0.80	±0.15	±0.10	0.10%		(I)
	C3216NP0121JHTSD	C3216NP0121JHT	1V, 1MHz	120	pF	±5%	0.80	±0.15	±0.10	0.10%		(I)
	C3216NP0151JHTSD	C3216NP0151JHT	1V, 1MHz	150	pF	±5%	0.80	±0.15	±0.10	0.10%		(I)
	C3216NP0181JHTSD	C3216NP0181JHT	1V, 1MHz	180	pF	±5%	0.80	±0.15	±0.10	0.10%		(I)
	C3216NP0221JHTSD	C3216NP0221JHT	1V, 1MHz	220	pF	±5%	0.80	±0.15	±0.10	0.10%		(I)
	C3216NP0271JHTSD	C3216NP0271JHT	1V, 1MHz	270	pF	±5%	0.80	±0.15	±0.10	0.10%		(I)
	C3216NP0331JHTSD	C3216NP0331JHT	1V, 1MHz	330	pF	±5%	0.80	±0.15	±0.10	0.10%		(I)
	C3216NP0391JHTSD	C3216NP0391JHT	1V, 1MHz	390	pF	±5%	0.80	±0.15	±0.10	0.10%		(I)
	C3216NP0471JHTSD	C3216NP0471JHT	1V, 1MHz	470	pF	±5%	0.80	±0.15	±0.10	0.10%		(I)
	C3216NP0561JHTSD	C3216NP0561JHT	1V, 1MHz	560	pF	±5%	0.80	±0.15	±0.10	0.10%		(I)
	C3216NP0681JHTSD	C3216NP0681JHT	1V, 1MHz	680	pF	±5%	0.80	±0.15	±0.10	0.10%		(I)
	C3216NP0821JHTSD	C3216NP0821JHT	1V, 1MHz	820	pF	±5%	0.80	±0.15	±0.10	0.10%		(I)
	C3216NP0102JHTSD	C3216NP0102JHT	1V, 1MHz	1.0	nF	±5%	0.80	±0.15	±0.10	0.10%		(I)
	C3216NP0122JHTSD	C3216NP0122JHT	1V, 1kHz	1.2	nF	±5%	0.80	±0.15	±0.10	0.10%		(I)
	C3216NP0152JHTSD	C3216NP0152JHT	1V, 1kHz	1.5	nF	±5%	0.80	±0.15	±0.10	0.10%		(I)
	C3216NP0182JHTSD	C3216NP0182JHT	1V, 1kHz	1.8	nF	±5%	0.80	±0.15	±0.10	0.10%		(I)
	C3216NP0222JHTSD	C3216NP0222JHT	1V, 1kHz	2.2	nF	±5%	0.80	±0.15	±0.10	0.10%		(I)
	C3216NP0272JHTSD	C3216NP0272JHT	1V, 1kHz	2.7	nF	±5%	0.80	±0.15	±0.10	0.10%		(I)
	C3216NP0332JHTSD	C3216NP0332JHT	1V, 1kHz	3.3	nF	±5%	0.80	±0.15	±0.10	0.10%		(I)
	C3216NP0392JHTSD	C3216NP0392JHT	1V, 1kHz	3.9	nF	±5%	0.80	±0.15	±0.10	0.10%		(I)
	C3216NP0472JHTSD	C3216NP0472JHT	1V, 1kHz	4.7	nF	±5%	0.80	±0.15	±0.10	0.10%		(I)
	C3216NP0562JHTSD	C3216NP0562JHT	1V, 1kHz	5.6	nF	±5%	0.80	±0.15	±0.10	0.10%		(I)
	C3216NP0682JHTSD	C3216NP0682JHT	1V, 1kHz	6.8	nF	±5%	0.80	±0.3/±0.2	±0.15	0.10%		(I)
	C3216NP0682JHPSPG		1V, 1kHz	6.8	nF	±5%	1.25	±0.15	±0.20	0.10%		(I)
C3216NP0822JHPSPG	C3216NP0822JHP	1V, 1kHz	8.2	nF	±5%	1.25	±0.15	±0.20	0.10%	Embossed,3Kpcs		
C3216NP0103JHPSPG	C3216NP0103JHP	1V, 1kHz	10	nF	±5%	1.25	±0.15	±0.20	0.10%	(I)		
C3216NP0333JHTSD	C3216NP0333JHT	1V, 1kHz	33	nF	±5%	0.80	±0.15	±0.15	0.10%	Paper,4Kpcs		
C3216NP0104JHPSL	C3216NP0104JHP	1V, 1kHz	100	nF	±5%	1.60	±0.30	±0.30	0.10%	Embossed,2Kpcs		

● C3225NP0 Series (EIA1210)

RV	DARFON P/N	DARFON P/N 2	Measuring Condition	Capacitance Value	Unit	Available Tolerance	Thick. (mm)	Tolerance(mm)		DF (max.)	Standard Packing	Test Spec.
								L/W	Thick.			
1000V	C3225NP0331JPPSL	C3225NP0331JPP	1V,1MHz	330	pF	±5%	1.60	±0.40/±0.30	±0.20	0.10%	Embossed, 2Kpcs	(I)
250V	C3225NP0103JKPSL	C3225NP0103JKP	1V, 1kHz	10	nF	±5%	1.60	±0.40/±0.30	±0.20	0.10%	Embossed, 2Kpcs	(I)
100V	C3225NP0102KHPSG	C3225NP0102KHP	1V,1MHz	1.0	nF	±10%	1.25	±0.30/±0.20	±0.20	0.10%	Embossed, 3Kpcs	(I)

● C4520NP0 Series (EIA1808)

RV	DARFON P/N	DARFON P/N 2	Measuring Condition	Capacitance		Available Tolerance	Thick. (mm)	Tolerance(mm)		DF (max.)	Standard Packing	Test Spec.
				Value	Unit			L/W	Thick.			
3000V	C4520NP0509DRPSG	C4520NP0509DRP	1V, 1MHz	5.0	pF	±0.5pF	1.25	+0.5-0.3/±0.3	±0.20	0.20%	Embossed, 3Kpcs	(I)
	C4520NP0100KRPSL	C4520NP0100KRP	1V, 1MHz	10	pF	±10%	1.60	±0.40/±0.30	±0.20	0.17%	Embossed, 2Kpcs	(I)
	C4520NP0150JRPSL	C4520NP0150JRP	1V, 1MHz	15	pF	±5%	1.60	±0.4/±0.3	±0.20	0.14%	Embossed, 2Kpcs	(I)
	C4520NP0470JRPSG	C4520NP0470JRP	1V, 1MHz	47	pF	±5%	1.25	+0.5-0.3/±0.3	±0.20	0.10%		(I)
	C4520NP0560□RPSG	C4520NP0560□RP	1V, 1MHz	56	pF	±5%, ±2%	1.25	+0.5-0.3/±0.3	±0.20	0.10%	Embossed, 3Kpcs	(I)
2000V	C4520NP0101JRPSG	C4520NP0101JRP	1V, 1MHz	100	pF	±5%	1.25	+0.5-0.3/±0.3	±0.20	0.10%		(I)
	C4520NP0180JQPSG	C4520NP0180JQP	1V, 1MHz	18	pF	±5%	1.25	+0.5-0.3/±0.3	±0.20	0.13%	Embossed, 3Kpcs	(I)
	C4520NP0101JQPSG	C4520NP0101JQP	1V, 1MHz	100	pF	±5%	1.25	+0.5-0.3/±0.3	±0.20	0.10%		(I)
	C4520NP0681JQPSN	C4520NP0681JQP	1V, 1MHz	680	pF	±5%	2.00	+0.5-0.3/±0.3	±0.20	0.10%	Embossed, 2Kpcs	(I)
	C4520NP0330JPPSG	C4520NP0330JPP	1V, 1MHz	33	pF	±5%	1.25	+0.5-0.3/±0.3	±0.20	0.10%	Embossed, 3Kpcs	(I)
1000V	C4520NP0681JPPSN	C4520NP0681JPP	1V, 1MHz	680	pF	±5%	2.00	+0.5-0.3/±0.3	±0.20	0.10%	Embossed, 2Kpcs	(I)
	250V	C4520NP0151JKPSG	C4520NP0151JKP	1V, 1MHz	150	pF	±5%	1.25	+0.5-0.3/±0.3	±0.20	0.10%	Embossed, 3Kpcs

□ Tolerance Code: C=±0.25pF, D=±0.5pF, G=±2%, J=±5%; Special tolerance on the request.

■ X8G Series

● C1608X8G Series (EIA0603)

RV	DARFON P/N	DARFON P/N 2	Measuring Condition	Capacitance		Available Tolerance	Thick. (mm)	Tolerance(mm)		DF (max.)	Standard Packing	Test Spec.
				Value	Unit			L/W	Thick.			
100V	C1608X8G221JHTS	C1608X8G221JHT	1V, 1MHz	220	pF	±5%	0.80	±0.10	±0.10	0.10%	Paper, 4Kpcs	(I)
	C1608X8G271JHTS	C1608X8G271JHT	1V, 1MHz	270	pF	±5%	0.80	±0.10	±0.10	0.10%		(I)
	C1608X8G331JHTS	C1608X8G331JHT	1V, 1MHz	330	pF	±5%	0.80	±0.10	±0.10	0.10%		(I)
	C1608X8G391JHTS	C1608X8G391JHT	1V, 1MHz	390	pF	±5%	0.80	±0.10	±0.10	0.10%		(I)
	C1608X8G471JHTS	C1608X8G471JHT	1V, 1MHz	470	pF	±5%	0.80	±0.10	±0.10	0.10%		(I)
	C1608X8G561JHTS	C1608X8G561JHT	1V, 1MHz	560	pF	±5%	0.80	±0.10	±0.10	0.10%		(I)
	C1608X8G681JHTS	C1608X8G681JHT	1V, 1MHz	680	pF	±5%	0.80	±0.10	±0.10	0.10%		(I)
	C1608X8G821JHTS	C1608X8G821JHT	1V, 1MHz	820	pF	±5%	0.80	±0.10	±0.10	0.10%		(I)
	C1608X8G102JHTS	C1608X8G102JHT	1V, 1MHz	1.0	nF	±5%	0.80	±0.10	±0.10	0.10%		(I)
	C1608X8G122JHTS	C1608X8G122JHT	1V, 1KHz	1.2	nF	±5%	0.80	+0.15/-0.10	+0.15/-0.10	0.10%		(I)
	C1608X8G222JHTS	C1608X8G222JHT	1V, 1KHz	2.2	nF	±5%	0.80	+0.15/-0.10	+0.15/-0.10	0.10%	(I)	

● C2012X8G Series (EIA0805)

RV	DARFON P/N	DARFON P/N 2	Measuring Condition	Capacitance		Available Tolerance	Thick. (mm)	Tolerance(mm)		DF (max.)	Standard Packing	Test Spec.
				Value	Unit			L/W	Thick.			
100V	C2012X8G201KHTSC		1V, 1MHz	200	pF	±10%	0.60	±0.15/±0.10	±0.10	0.10%	Paper, 4Kpcs	(I)

■ X5R Series

● C1005X5R Series (EIA0402)

RV	DARFON P/N	DARFON P/N 2	Measuring Condition	Capacitance		Available Tolerance	Thick. (mm)	Tolerance(mm)		DF (max.)	Standard Packing	Test Spec.
				Value	Unit			L/W	Thick.			
100V	C1005X5R104KHTS	C1005X5R104KHT	1V , 1kHz	100	nF	±10%	0.50	±0.05	±0.05	10.0%	Paper, 10Kpcs	(II)*

● C1608X5R Series (EIA0603)

RV	DARFON P/N	DARFON P/N 2	Measuring Condition	Capacitance		Available Tolerance	Thick. (mm)	Tolerance(mm)		DF (max.)	Standard Packing	Test Spec.
				Value	Unit			L/W	Thick.			
100V	C1608X5R223KHTS	C1608X5R223KHT	1V , 1kHz	22	nF	±10%	0.80	±0.10	±0.10	5.0%	Paper, 4Kpcs	(I)

■ X7R Series
● C1005X7R Series (EIA0402)

RV	DARFON P/N	DARFON P/N 2	Measuring Condition	Capacitance		Available Tolerance	Thick. (mm)	Tolerance(mm)		DF (max.)	Standard Packing	Test Spec.
				Value	Unit			L/W	Thick.			
100V	C1005X7R101KHST	C1005X7R101KHT	1V, 1kHz	100	pF	±10%	0.50	±0.05	±0.05	3.0%	Paper, 10Kpcs	(I)
	C1005X7R121KHST	C1005X7R121KHT	1V, 1kHz	120	pF	±10%	0.50	±0.05	±0.05	3.0%		(I)
	C1005X7R151KHST	C1005X7R151KHT	1V, 1kHz	150	pF	±10%	0.50	±0.05	±0.05	3.0%		(I)
	C1005X7R181KHST	C1005X7R181KHT	1V, 1kHz	180	pF	±10%	0.50	±0.05	±0.05	3.0%		(I)
	C1005X7R221KHST	C1005X7R221KHT	1V, 1kHz	220	pF	±10%	0.50	±0.05	±0.05	3.0%		(I)
	C1005X7R271KHST	C1005X7R271KHT	1V, 1kHz	270	pF	±10%	0.50	±0.05	±0.05	3.0%		(I)
	C1005X7R331KHST	C1005X7R331KHT	1V, 1kHz	330	pF	±10%	0.50	±0.05	±0.05	3.0%		(I)
	C1005X7R391KHST	C1005X7R391KHT	1V, 1kHz	390	pF	±10%	0.50	±0.05	±0.05	3.0%		(I)
	C1005X7R471KHST	C1005X7R471KHT	1V, 1kHz	470	pF	±10%	0.50	±0.05	±0.05	3.0%		(I)
	C1005X7R561KHST	C1005X7R561KHT	1V, 1kHz	560	pF	±10%	0.50	±0.05	±0.05	3.0%		(I)
	C1005X7R681KHST	C1005X7R681KHT	1V, 1kHz	680	pF	±10%	0.50	±0.05	±0.05	3.0%		(I)
	C1005X7R821KHST	C1005X7R821KHT	1V, 1kHz	820	pF	±10%	0.50	±0.05	±0.05	3.0%		(I)
	C1005X7R102KHST	C1005X7R102KHT	1V, 1kHz	1.0	nF	±10%	0.50	±0.05	±0.05	3.0%		(I)
	C1005X7R122KHST	C1005X7R122KHT	1V, 1kHz	1.2	nF	±10%	0.50	±0.05	±0.05	3.0%		(I)
	C1005X7R152KHST	C1005X7R152KHT	1V, 1kHz	1.5	nF	±10%	0.50	±0.05	±0.05	3.0%		(I)
	C1005X7R182KHST	C1005X7R182KHT	1V, 1kHz	1.8	nF	±10%	0.50	±0.05	±0.05	3.0%		(I)
	C1005X7R222KHST	C1005X7R222KHT	1V, 1kHz	2.2	nF	±10%	0.50	±0.05	±0.05	3.0%		(I)
	C1005X7R272KHST	C1005X7R272KHT	1V, 1kHz	2.7	nF	±10%	0.50	±0.05	±0.05	3.0%		(I)
	C1005X7R332KHST	C1005X7R332KHT	1V, 1kHz	3.3	nF	±10%	0.50	±0.05	±0.05	3.0%		(I)
	C1005X7R392KHST	C1005X7R392KHT	1V, 1kHz	3.9	nF	±10%	0.50	±0.05	±0.05	3.0%		(I)
C1005X7R472KHST	C1005X7R472KHT	1V, 1kHz	4.7	nF	±10%	0.50	±0.05	±0.05	3.0%	(I)		
C1005X7R562KHST	C1005X7R562KHT	1V, 1kHz	5.6	nF	±10%	0.50	±0.05	±0.05	3.0%	(I)		
C1005X7R682KHST	C1005X7R682KHT	1V, 1kHz	6.8	nF	±10%	0.50	±0.05	±0.05	3.0%	(I)		
C1005X7R103KHST	C1005X7R103KHT	1V, 1kHz	10	nF	±10%	0.50	±0.05	±0.05	3.0%	(I)		

● C1608X7R Series (EIA0603)

RV	DARFON P/N	DARFON P/N 2	Measuring Condition	Capacitance		Available Tolerance	Thick. (mm)	Tolerance(mm)		DF (max.)	Standard Packing	Test Spec.
				Value	Unit			L/W	Thick.			
250V	C1608X7R101KKTS	C1608X7R101KKKT	1V, 1kHz	100	pF	±10%	0.80	±0.10	±0.10	2.5%	Paper, 4Kpcs	(I)
	C1608X7R121KKTS	C1608X7R121KKKT	1V, 1kHz	120	pF	±10%	0.80	±0.10	±0.10	2.5%		(I)
	C1608X7R151KKTS	C1608X7R151KKKT	1V, 1kHz	150	pF	±10%	0.80	±0.10	±0.10	2.5%		(I)
	C1608X7R181KKTS	C1608X7R181KKKT	1V, 1kHz	180	pF	±10%	0.80	±0.10	±0.10	2.5%		(I)
	C1608X7R221KKTS	C1608X7R221KKKT	1V, 1kHz	220	pF	±10%	0.80	±0.10	±0.10	2.5%		(I)
	C1608X7R271KKTS	C1608X7R271KKKT	1V, 1kHz	270	pF	±10%	0.80	±0.10	±0.10	2.5%		(I)
	C1608X7R331KKTS	C1608X7R331KKKT	1V, 1kHz	330	pF	±10%	0.80	±0.10	±0.10	2.5%		(I)
	C1608X7R391KKTS	C1608X7R391KKKT	1V, 1kHz	390	pF	±10%	0.80	±0.10	±0.10	2.5%		(I)
	C1608X7R471KKTS	C1608X7R471KKKT	1V, 1kHz	470	pF	±10%	0.80	±0.10	±0.10	2.5%		(I)
	C1608X7R561KKTS	C1608X7R561KKKT	1V, 1kHz	560	pF	±10%	0.80	±0.10	±0.10	2.5%		(I)
	C1608X7R681KKTS	C1608X7R681KKKT	1V, 1kHz	680	pF	±10%	0.80	±0.10	±0.10	2.5%		(I)
	C1608X7R821KKTS	C1608X7R821KKKT	1V, 1kHz	820	pF	±10%	0.80	±0.10	±0.10	2.5%		(I)
	C1608X7R102KKTS	C1608X7R102KKKT	1V, 1kHz	1.0	nF	±10%	0.80	±0.10	±0.10	2.5%		(I)
	C1608X7R122KKTS	C1608X7R122KKKT	1V, 1kHz	1.2	nF	±10%	0.80	±0.10	±0.10	2.5%		(I)
	C1608X7R152KKTS	C1608X7R152KKKT	1V, 1kHz	1.5	nF	±10%	0.80	±0.10	±0.10	2.5%		(I)
	C1608X7R182KKTS	C1608X7R182KKKT	1V, 1kHz	1.8	nF	±10%	0.80	±0.10	±0.10	2.5%		(I)
	C1608X7R222KKTS	C1608X7R222KKKT	1V, 1kHz	2.2	nF	±10%	0.80	±0.10	±0.10	2.5%		(I)
	C1608X7R272KKTS	C1608X7R272KKKT	1V, 1kHz	2.7	nF	±10%	0.80	±0.10	±0.10	2.5%		(I)
	C1608X7R332KKTS	C1608X7R332KKKT	1V, 1kHz	3.3	nF	±10%	0.80	±0.10	±0.10	2.5%		(I)
	C1608X7R392KKTS	C1608X7R392KKKT	1V, 1kHz	3.9	nF	±10%	0.80	±0.10	±0.10	2.5%		(I)
C1608X7R472KKTS	C1608X7R472KKKT	1V, 1kHz	4.7	nF	±10%	0.80	±0.10	±0.10	2.5%	(I)		
C1608X7R562KKTS	C1608X7R562KKKT	1V, 1kHz	5.6	nF	±10%	0.80	±0.10	±0.10	2.5%	(I)		
C1608X7R682KKTS	C1608X7R682KKKT	1V, 1kHz	6.8	nF	±10%	0.80	±0.10	±0.10	2.5%	(I)		
C1608X7R103KKTS	C1608X7R103KKKT	1V, 1kHz	10	nF	±10%	0.80	±0.15	±0.15	2.5%	(I)		
200V	C1608X7R331KJTS	C1608X7R331KJKT	1V, 1kHz	330	pF	±10%	0.80	±0.10	±0.10	2.5%	Paper, 4Kpcs	(I)
	C1608X7R821KJTS	C1608X7R821KJKT	1V, 1kHz	820	pF	±10%	0.80	±0.10	±0.10	2.5%		(I)
	C1608X7R102KJTS	C1608X7R102KJKT	1V, 1kHz	1.0	nF	±10%	0.80	±0.10	±0.10	2.5%		(I)
	C1608X7R222KJTS	C1608X7R222KJKT	1V, 1kHz	2.2	nF	±10%	0.80	±0.10	±0.10	2.5%		(I)
	C1608X7R332KJTS	C1608X7R332KJKT	1V, 1kHz	3.3	nF	±10%	0.80	±0.10	±0.10	2.5%		(I)
	C1608X7R472KJTS	C1608X7R472KJKT	1V, 1kHz	4.7	nF	±10%	0.80	±0.10	±0.10	2.5%		(I)
	C1608X7R103KJTS	C1608X7R103KJKT	1V, 1kHz	10	nF	±10%	0.80	±0.15	±0.15	2.5%		(I)

RV	DARFON P/N	DARFON P/N 2	Measuring Condition	Capacitance		Available Tolerance	Thick. (mm)	Tolerance(mm)		DF (max.)	Standard Packing	Test Spec.
				Value	Unit			L/W	Thick.			
100V	C1608X7R101KHTS	C1608X7R101KHT	1V, 1kHz	100	pF	±10%	0.80	±0.10	±0.10	3.0%	Paper, 4Kpcs	(I)
	C1608X7R121KHTS	C1608X7R121KHT	1V, 1kHz	120	pF	±10%	0.80	±0.10	±0.10	3.0%		(I)
	C1608X7R151KHTS	C1608X7R151KHT	1V, 1kHz	150	pF	±10%	0.80	±0.10	±0.10	3.0%		(I)
	C1608X7R181KHTS	C1608X7R181KHT	1V, 1kHz	180	pF	±10%	0.80	±0.10	±0.10	3.0%		(I)
	C1608X7R221KHTS	C1608X7R221KHT	1V, 1kHz	220	pF	±10%	0.80	±0.10	±0.10	3.0%		(I)
	C1608X7R271KHTS	C1608X7R271KHT	1V, 1kHz	270	pF	±10%	0.80	±0.10	±0.10	3.0%		(I)
	C1608X7R331KHTS	C1608X7R331KHT	1V, 1kHz	330	pF	±10%	0.80	±0.10	±0.10	3.0%		(I)
	C1608X7R391KHTS	C1608X7R391KHT	1V, 1kHz	390	pF	±10%	0.80	±0.10	±0.10	3.0%		(I)
	C1608X7R471KHTS	C1608X7R471KHT	1V, 1kHz	470	pF	±10%	0.80	±0.10	±0.10	3.0%		(I)
	C1608X7R561KHTS	C1608X7R561KHT	1V, 1kHz	560	pF	±10%	0.80	±0.10	±0.10	3.0%		(I)
	C1608X7R681KHTS	C1608X7R681KHT	1V, 1kHz	680	pF	±10%	0.80	±0.10	±0.10	3.0%		(I)
	C1608X7R821KHTS	C1608X7R821KHT	1V, 1kHz	820	pF	±10%	0.80	±0.10	±0.10	3.0%		(I)
	C1608X7R102KHTS	C1608X7R102KHT	1V, 1kHz	1.0	nF	±10%	0.80	±0.10	±0.10	3.0%		(I)
	C1608X7R122KHTS	C1608X7R122KHT	1V, 1kHz	1.2	nF	±10%	0.80	±0.10	±0.10	3.0%		(I)
	C1608X7R152KHTS	C1608X7R152KHT	1V, 1kHz	1.5	nF	±10%	0.80	±0.10	±0.10	3.0%		(I)
	C1608X7R182KHTS	C1608X7R182KHT	1V, 1kHz	1.8	nF	±10%	0.80	±0.10	±0.10	3.0%		(I)
	C1608X7R222KHTS	C1608X7R222KHT	1V, 1kHz	2.2	nF	±10%	0.80	±0.10	±0.10	3.0%		(I)
	C1608X7R272KHTS	C1608X7R272KHT	1V, 1kHz	2.7	nF	±10%	0.80	±0.10	±0.10	3.0%		(I)
	C1608X7R332KHTS	C1608X7R332KHT	1V, 1kHz	3.3	nF	±10%	0.80	±0.10	±0.10	3.0%		(I)
	C1608X7R392KHTS	C1608X7R392KHT	1V, 1kHz	3.9	nF	±10%	0.80	±0.10	±0.10	3.0%		(I)
	C1608X7R472KHTS	C1608X7R472KHT	1V, 1kHz	4.7	nF	±10%	0.80	±0.10	±0.10	3.0%		(I)
	C1608X7R562KHTS	C1608X7R562KHT	1V, 1kHz	5.6	nF	±10%	0.80	±0.10	±0.10	3.0%		(I)
	C1608X7R682KHTS	C1608X7R682KHT	1V, 1kHz	6.8	nF	±10%	0.80	±0.10	±0.10	3.0%		(I)
	C1608X7R822KHTS	C1608X7R822KHT	1V, 1kHz	8.2	nF	±10%	0.80	±0.10	±0.10	3.0%		(I)
	C1608X7R103KHTS	C1608X7R103KHT	1V, 1kHz	10	nF	±10%	0.80	±0.10	±0.10	3.0%		(I)
	C1608X7R123KHTS	C1608X7R123KHT	1V, 1kHz	12	nF	±10%	0.80	±0.10	±0.10	3.0%		(I)
	C1608X7R153KHTS	C1608X7R153KHT	1V, 1kHz	15	nF	±10%	0.80	±0.10	±0.10	3.0%		(I)
	C1608X7R223KHTS	C1608X7R223KHT	1V, 1kHz	22	nF	±10%	0.80	±0.10	±0.10	3.0%		(I)
	C1608X7R333KHTS	C1608X7R333KHT	1V, 1kHz	33	nF	±10%	0.80	±0.15	±0.15	3.0%		(I)
	C1608X7R393KHTS	C1608X7R393KHT	1V, 1kHz	39	nF	±10%	0.80	±0.15	±0.15	3.0%		(I)
	C1608X7R473KHTS	C1608X7R473KHT	1V, 1kHz	47	nF	±10%	0.80	±0.15	±0.15	3.0%		(I)
	C1608X7R563KHTS	C1608X7R563KHT	1V, 1kHz	56	nF	±10%	0.80	±0.15	±0.15	5.0%		(I)
	C1608X7R683KHTS	C1608X7R683KHT	1V, 1kHz	68	nF	±10%	0.80	±0.15	±0.15	5.0%		(I)
C1608X7R823KHTS	C1608X7R823KHT	1V, 1kHz	82	nF	±10%	0.80	±0.15	±0.15	5.0%	(I)		
C1608X7R104□HTS	C1608X7R104□HT	1V, 1kHz	100	nF	±5%, ±10%, ±20%	0.80	±0.15	±0.15	10.0%	(I)		

□ Tolerance Code: J=±5%, K=±10%, M=±20%; Special tolerance on the request.

● C2012X7R Series (EIA0805)

RV	DARFON P/N	DARFON P/N 2	Measuring Condition	Capacitance		Available Tolerance	Thick. (mm)	Tolerance(mm)		DF (max.)	Standard Packing	Test Spec.
				Value	Unit			L/W	Thick.			
1000V	C2012X7R101□PTSD	C2012X7R101□PT	1V, 1kHz	100	pF	±10%, ±20%	0.80	±0.15	±0.10	2.5%	Paper, 4Kpcs	(I)
	C2012X7R271KPTSD	C2012X7R271KPT	1V, 1kHz	270	pF	±10%	0.80	±0.15	±0.10	2.5%		(I)
630V	C2012X7R101KMTSD	C2012X7R101KMT	1V, 1kHz	100	pF	±10%	0.80	±0.15	±0.10	2.5%	Paper, 4Kpcs	(I)
	C2012X7R151KMTSD	C2012X7R151KMT	1V, 1kHz	150	pF	±10%	0.80	±0.15	±0.10	2.5%		(I)
	C2012X7R181KMTSD	C2012X7R181KMT	1V, 1kHz	180	pF	±10%	0.80	±0.15	±0.10	2.5%		(I)
	C2012X7R221KMTSD	C2012X7R221KMT	1V, 1kHz	220	pF	±10%	0.80	±0.15	±0.10	2.5%		(I)
	C2012X7R271KMTSD	C2012X7R271KMT	1V, 1kHz	270	pF	±10%	0.80	±0.15	±0.10	2.5%		(I)
	C2012X7R331KMTSD	C2012X7R331KMT	1V, 1kHz	330	pF	±10%	0.80	±0.15	±0.10	2.5%		(I)
	C2012X7R391KMTSD	C2012X7R391KMT	1V, 1kHz	390	pF	±10%	0.80	±0.15	±0.10	2.5%		(I)
	C2012X7R471KMTSD	C2012X7R471KMT	1V, 1kHz	470	pF	±10%	0.80	±0.15	±0.10	2.5%		(I)
	C2012X7R561KMTSD	C2012X7R561KMT	1V, 1kHz	560	pF	±10%	0.80	±0.15	±0.10	2.5%		(I)
	C2012X7R681KMTSD	C2012X7R681KMT	1V, 1kHz	680	pF	±10%	0.80	±0.15	±0.10	2.5%		(I)
	C2012X7R821KMTSD	C2012X7R821KMT	1V, 1kHz	820	pF	±10%	0.80	±0.15	±0.10	2.5%	(I)	
	C2012X7R102KMTSD	C2012X7R102KMT	1V, 1kHz	1.0	nF	±10%	0.80	±0.15	±0.10	2.5%	(I)	
	C2012X7R122KMTSD	C2012X7R122KMT	1V, 1kHz	1.2	nF	±10%	0.80	±0.15	±0.10	2.5%	(I)	
	C2012X7R152KMTSD	C2012X7R152KMT	1V, 1kHz	1.5	nF	±10%	0.80	±0.15	±0.10	2.5%	(I)	
	C2012X7R182KMTSD	C2012X7R182KMT	1V, 1kHz	1.8	nF	±10%	0.80	±0.15	±0.10	2.5%	(I)	
	C2012X7R222KMTSD	C2012X7R222KMT	1V, 1kHz	2.2	nF	±10%	0.80	±0.15	±0.10	2.5%	(I)	
	C2012X7R272KMTSD	C2012X7R272KMT	1V, 1kHz	2.7	nF	±10%	0.80	±0.15	±0.10	2.5%	(I)	
	C2012X7R332KMTSD	C2012X7R332KMT	1V, 1kHz	3.3	nF	±10%	0.80	±0.15	±0.10	2.5%	(I)	
	C2012X7R472KMPSG	C2012X7R472KMP	1V, 1kHz	4.7	nF	±10%	1.25	±0.15	±0.20	2.5%	Embossed, 3Kpcs	(I)
	C2012X7R103KMPSG	C2012X7R103KMP	1V, 1kHz	10	nF	±10%	1.25	±0.15	±0.20	2.5%		(I)
C2012X7R223KMPSG	C2012X7R223KMP	1V, 1kHz	22	nF	±10%	1.25	±0.15	±0.20	2.5%	(I)		
500V	C2012X7R101KLTSD	C2012X7R101KLT	1V, 1kHz	100	pF	±10%	0.80	±0.15	±0.10	2.5%	Paper, 4Kpcs	(I)
	C2012X7R181KLTSD	C2012X7R181KLT	1V, 1kHz	180	pF	±10%	0.80	±0.15	±0.10	2.5%		(I)
	C2012X7R221KLTSD	C2012X7R221KLT	1V, 1kHz	220	pF	±10%	0.80	±0.15	±0.10	2.5%		(I)
	C2012X7R271KLTSD	C2012X7R271KLT	1V, 1kHz	270	pF	±10%	0.80	±0.15	±0.10	2.5%		(I)
	C2012X7R331KLTSD	C2012X7R331KLT	1V, 1kHz	330	pF	±10%	0.80	±0.15	±0.10	2.5%		(I)
	C2012X7R471KLTSD	C2012X7R471KLT	1V, 1kHz	470	pF	±10%	0.80	±0.15	±0.10	2.5%		(I)
	C2012X7R561KLTSD	C2012X7R561KLT	1V, 1kHz	560	pF	±10%	0.80	±0.15	±0.10	2.5%		(I)
	C2012X7R681KLTSD	C2012X7R681KLT	1V, 1kHz	680	pF	±10%	0.80	±0.15	±0.10	2.5%		(I)
	C2012X7R102KLTSD	C2012X7R102KLT	1V, 1kHz	1.0	nF	±10%	0.80	±0.15	±0.10	2.5%		(I)
	C2012X7R222KLTSD	C2012X7R222KLT	1V, 1kHz	2.2	nF	±10%	0.80	±0.15	±0.10	2.5%		(I)
	C2012X7R272KLTSD	C2012X7R272KLT	1V, 1kHz	2.7	nF	±10%	0.80	±0.15	±0.10	2.5%	(I)	
	C2012X7R472KLPSPG	C2012X7R472KLP	1V, 1kHz	4.7	nF	±10%	1.25	±0.15	±0.20	2.5%	Embossed, 3Kpcs	(I)
	C2012X7R103KLPSPG	C2012X7R103KLP	1V, 1kHz	10	nF	±10%	1.25	±0.15	±0.20	2.5%		(I)
	C2012X7R223KLPSPG	C2012X7R223KLP	1V, 1kHz	22	nF	±10%	1.25	±0.15	±0.20	2.5%		(I)
C2012X7R121KKTSD	C2012X7R121KKT	1V, 1kHz	120	pF	±10%	0.80	±0.15	±0.10	2.5%	(I)		
250V	C2012X7R181KKTSD	C2012X7R181KKT	1V, 1kHz	180	pF	±10%	0.80	±0.15	±0.10	2.5%	Paper, 4Kpcs	(I)
	C2012X7R221KKTSD	C2012X7R221KKT	1V, 1kHz	220	pF	±10%	0.80	±0.15	±0.10	2.5%		(I)
	C2012X7R331KKTSD	C2012X7R331KKT	1V, 1kHz	330	pF	±10%	0.80	±0.15	±0.10	2.5%		(I)
	C2012X7R471KKTSD	C2012X7R471KKT	1V, 1kHz	470	pF	±10%	0.80	±0.15	±0.10	2.5%		(I)
	C2012X7R561KKTSD	C2012X7R561KKT	1V, 1kHz	560	pF	±10%	0.80	±0.15	±0.10	2.5%		(I)
	C2012X7R681KKTSD	C2012X7R681KKT	1V, 1kHz	680	pF	±10%	0.80	±0.15	±0.10	2.5%		(I)
	C2012X7R102KKTSD	C2012X7R102KKT	1V, 1kHz	1.0	nF	±10%	0.80	±0.15	±0.10	2.5%		(I)
	C2012X7R122KKTSD	C2012X7R122KKT	1V, 1kHz	1.2	nF	±10%	0.80	±0.15	±0.10	2.5%		(I)
	C2012X7R152KKTSD	C2012X7R152KKT	1V, 1kHz	1.5	nF	±10%	0.80	±0.15	±0.10	2.5%		(I)
	C2012X7R222□KTSD	C2012X7R222□KT	1V, 1kHz	2.2	nF	±10%, ±5%	0.80	±0.15	±0.10	2.5%		(I)
	C2012X7R332KKTSD	C2012X7R332KKT	1V, 1kHz	3.3	nF	±10%	0.80	±0.15	±0.10	2.5%	(I)	
	C2012X7R392KKTSD	C2012X7R392KKT	1V, 1kHz	3.9	nF	±10%	0.80	±0.15	±0.10	2.5%	(I)	
	C2012X7R472KKTSD	C2012X7R472KKT	1V, 1kHz	4.7	nF	±10%	0.80	±0.15	±0.10	2.5%	(I)	
	C2012X7R562KPPSG	C2012X7R562KPP	1V, 1kHz	5.6	nF	±10%	1.25	±0.15	±0.20	2.5%	Embossed, 3Kpcs	(I)
	C2012X7R682KPPSG	C2012X7R682KPP	1V, 1kHz	6.8	nF	±10%	1.25	±0.15	±0.20	2.5%		(I)
	C2012X7R822KPPSG	C2012X7R822KPP	1V, 1kHz	8.2	nF	±10%	1.25	±0.15	±0.20	2.5%		(I)
	C2012X7R103KPPSG	C2012X7R103KPP	1V, 1kHz	10	nF	±10%	1.25	±0.15	±0.20	2.5%		(I)
	C2012X7R123KPPSG	C2012X7R123KPP	1V, 1kHz	12	nF	±10%	1.25	±0.15	±0.20	2.5%		(I)
	C2012X7R153KPPSG	C2012X7R153KPP	1V, 1kHz	15	nF	±10%	1.25	±0.15	±0.20	2.5%		(I)
	C2012X7R223KPPSG	C2012X7R223KPP	1V, 1kHz	22	nF	±10%	1.25	±0.20	±0.20	2.5%		(I)
C2012X7R333KPPSG	C2012X7R333KPP	1V, 1kHz	33	nF	±10%	1.25	±0.20	±0.20	2.5%	(I)		
C2012X7R473KPPSG	C2012X7R473KPP	1V, 1kHz	47	nF	±10%	1.25	±0.20	±0.20	2.5%	(II)		
C2012X7R683KPPSG	C2012X7R683KPP	1V, 1kHz	68	nF	±10%	1.25	±0.20	±0.20	2.5%	(II)		
200V	C2012X7R104KPPSG	C2012X7R104KPP	1V, 1kHz	100	nF	±10%	1.25	±0.20	±0.20	2.5%	(II)	
	C2012X7R221KJTSD	C2012X7R221KJT	1V, 1kHz	220	pF	±10%	0.80	±0.15	±0.10	2.5%	Paper, 4Kpcs	(I)
	C2012X7R471KJTSD	C2012X7R471KJT	1V, 1kHz	470	pF	±10%	0.80	±0.15	±0.10	2.5%		(I)
	C2012X7R102KJTSD	C2012X7R102KJT	1V, 1kHz	1.0	nF	±10%	0.80	±0.15	±0.10	2.5%		(I)
	C2012X7R103KJPSPG	C2012X7R103KJP	1V, 1kHz	10	nF	±10%	1.25	±0.15	±0.20	2.5%	Embossed, 3Kpcs	(I)
	C2012X7R153KJPSPG	C2012X7R153KJP	1V, 1kHz	15	nF	±10%	1.25	±0.15	±0.20	2.5%		(I)
	C2012X7R223KJPSPG	C2012X7R223KJP	1V, 1kHz	22	nF	±10%	1.25	±0.20	±0.20	2.5%		(I)
	C2012X7R473KJPSPG	C2012X7R473KJP	1V, 1kHz	47	nF	±10%	1.25	±0.20	±0.20	2.5%		(II)
	C2012X7R683KJPSPG	C2012X7R683KJP	1V, 1kHz	68	nF	±10%	1.25	±0.20	±0.20	2.5%		(II)
	C2012X7R104KJPSPG	C2012X7R104KJP	1V, 1kHz	100	nF	±10%	1.25	±0.20	±0.20	2.5%		(II)

□ Tolerance Code: J=±5%, K=±10%, M=±20%; Special tolerance on the request.

RV	DARFON P/N	DARFON P/N 2	Measuring Condition	Capacitance		Available Tolerance	Thick. (mm)	Tolerance(mm)		DF (max.)	Standard Packing	Test Spec.	
				Value	Unit			L/W	Thick.				
100V	C2012X7R151KHTSD	C2012X7R151KHT	1V, 1kHz	150	pF	±10%	0.80	±0.15	±0.10	3.0%	Paper, 4Kpcs	(I)	
	C2012X7R181KHTSD	C2012X7R181KHT	1V, 1kHz	180	pF	±10%	0.80	±0.15	±0.10	3.0%		(I)	
	C2012X7R221□HTSD	C2012X7R221□HT	1V, 1kHz	220	pF	±5%, ±10%	0.80	±0.15	±0.10	3.0%		(I)	
	C2012X7R271KHTSD	C2012X7R271KHT	1V, 1kHz	270	pF	±10%	0.80	±0.15	±0.10	3.0%		(I)	
	C2012X7R331KHTSD	C2012X7R331KHT	1V, 1kHz	330	pF	±10%	0.80	±0.15	±0.10	3.0%		(I)	
	C2012X7R391KHTSD	C2012X7R391KHT	1V, 1kHz	390	pF	±10%	0.80	±0.15	±0.10	3.0%		(I)	
	C2012X7R471KHTSD	C2012X7R471KHT	1V, 1kHz	470	pF	±10%	0.80	±0.15	±0.10	3.0%		(I)	
	C2012X7R561KHTSD	C2012X7R561KHT	1V, 1kHz	560	pF	±10%	0.80	±0.15	±0.10	3.0%		(I)	
	C2012X7R681KHTSD	C2012X7R681KHT	1V, 1kHz	680	pF	±10%	0.80	±0.15	±0.10	3.0%		(I)	
	C2012X7R821KHTSD	C2012X7R821KHT	1V, 1kHz	820	pF	±10%	0.80	±0.15	±0.10	3.0%		(I)	
	C2012X7R102KHTSD	C2012X7R102KHT	1V, 1kHz	1.0	nF	±10%	0.80	±0.15	±0.10	3.0%		(I)	
	C2012X7R102KHTSE		1V, 1kHz	1.0	nF	±10%	0.85	±0.15	±0.10	3.0%		(I)	
	C2012X7R122KHTSD	C2012X7R122KHT	1V, 1kHz	1.2	nF	±10%	0.80	±0.15	±0.10	3.0%		(I)	
	C2012X7R152KHTSD	C2012X7R152KHT	1V, 1kHz	1.5	nF	±10%	0.80	±0.15	±0.10	3.0%		(I)	
	C2012X7R182KHTSD	C2012X7R182KHT	1V, 1kHz	1.8	nF	±10%	0.80	±0.15	±0.10	3.0%		(I)	
	C2012X7R222KHTSD	C2012X7R222KHT	1V, 1kHz	2.2	nF	±10%	0.80	±0.15	±0.10	3.0%		(I)	
	C2012X7R272KHTSD	C2012X7R272KHT	1V, 1kHz	2.7	nF	±10%	0.80	±0.15	±0.10	3.0%		(I)	
	C2012X7R332KHTSD	C2012X7R332KHT	1V, 1kHz	3.3	nF	±10%	0.80	±0.15	±0.10	3.0%		(I)	
	C2012X7R392KHTSD	C2012X7R392KHT	1V, 1kHz	3.9	nF	±10%	0.80	±0.15	±0.10	3.0%		(I)	
	C2012X7R472KHTSD	C2012X7R472KHT	1V, 1kHz	4.7	nF	±10%	0.80	±0.15	±0.10	3.0%		(I)	
	C2012X7R562KHTSD	C2012X7R562KHT	1V, 1kHz	5.6	nF	±10%	0.80	±0.15	±0.10	3.0%		(I)	
	C2012X7R682KHTSD	C2012X7R682KHT	1V, 1kHz	6.8	nF	±10%	0.80	±0.15	±0.10	3.0%		(I)	
	C2012X7R822KHTSD	C2012X7R822KHT	1V, 1kHz	8.2	nF	±10%	0.80	±0.15	±0.10	3.0%		(I)	
	C2012X7R103KHTSD	C2012X7R103KHT	1V, 1kHz	10	nF	±10%	0.80	±0.15	±0.10	3.0%		(I)	
	C2012X7R123KHTSD		1V, 1kHz	12	nF	±10%	0.80	±0.15	±0.10	3.0%		(I)	
	C2012X7R153KHTSD	C2012X7R153KHT	1V, 1kHz	15	nF	±10%	0.80	±0.15	±0.10	3.0%		(I)	
	C2012X7R183KHTSD	C2012X7R183KHT	1V, 1kHz	18	nF	±10%	0.80	±0.15	±0.10	3.0%		(I)	
	C2012X7R223KHTSD	C2012X7R223KHT	1V, 1kHz	22	nF	±10%	0.80	±0.15	±0.10	3.0%		(I)	
	C2012X7R333KHTSD	C2012X7R333KHT	1V, 1kHz	33	nF	±10%	0.80	±0.15	±0.10	3.0%		(I)	
	C2012X7R333KHPSPG	C2012X7R333KHP	1V, 1kHz	33	nF	±10%	1.25	±0.15/±0.10	±0.10	2.5%		Embossed, 3Kpcs	(I)
	C2012X7R393KHPSPG	C2012X7R393KHP	1V, 1kHz	39	nF	±10%	1.25	±0.15/±0.10	±0.10	2.5%			(I)
	C2012X7R473KHPSPG	C2012X7R473KHP	1V, 1kHz	47	nF	±10%	1.25	±0.15/±0.10	±0.10	2.5%			(I)
	C2012X7R473KHWGSG		1V, 1kHz	47	nF	±10%	1.25	±0.15/±0.10	±0.10	2.5%		Embossed, 2Kpcs	(I)
	C2012X7R563KHPSPG	C2012X7R563KHP	1V, 1kHz	56	nF	±10%	1.25	±0.15/±0.10	±0.10	2.5%			(I)
	C2012X7R683KHPSPG	C2012X7R683KHP	1V, 1kHz	68	nF	±10%	1.25	±0.15/±0.10	±0.10	2.5%		Embossed, 3Kpcs	(I)
	C2012X7R823KHPSPG	C2012X7R823KHP	1V, 1kHz	82	nF	±10%	1.25	±0.15/±0.10	±0.10	2.5%			(I)
C2012X7R104□HPSPG	C2012X7R104□HP	1V, 1kHz	100	nF	±10%, ±20%	1.25	±0.20	±0.20	5.0%	(I)			
C2012X7R154KHPSPG	C2012X7R154KHP	1V, 1kHz	150	nF	±10%	1.25	±0.20	±0.20	5.0%	(I)			
C2012X7R224KHPSPG		1V, 1kHz	220	nF	±10%	1.25	±0.20	±0.20	5.0%	(I)			
C2012X7R334□HPSPG	C2012X7R334□HP	1V, 1kHz	330	nF	±10%, ±20%	1.25	±0.20	±0.20	5.0%	(II)			
C2012X7R474KHPSPG	C2012X7R474KHP	1V, 1kHz	470	nF	±10%	1.25	±0.20	±0.20	5.0%	(II)			
C2012X7R105KHPSPG	C2012X7R105KHP	1V, 1kHz	1.0	uF	±10%	1.25	±0.20	±0.20	5.0%	(II)			

● C3216X7R Series (EIA1206)

RV	DARFON P/N	DARFON P/N 2	Measuring Condition	Capacitance		Available Tolerance	Thick. (mm)	Tolerance(mm)		DF (max.)	Standard Packing	Test Spec.
				Value	Unit			L/W	Thick.			
2000V	C3216X7R101KQPSG	C3216X7R101KQP	1V, 1kHz	100	pF	±10%	1.25	±0.30	±0.20	2.5%	Embossed, 3Kpcs	(I)
	C3216X7R151KQPSG	C3216X7R151KQP	1V, 1kHz	150	pF	±10%	1.25	±0.30	±0.20	2.5%		(I)
	C3216X7R181KQPSG	C3216X7R181KQP	1V, 1kHz	180	pF	±10%	1.25	±0.30	±0.20	2.5%		(I)
	C3216X7R221KQPSG	C3216X7R221KQP	1V, 1kHz	220	pF	±10%	1.25	±0.30	±0.20	2.5%		(I)
	C3216X7R271KQPSG	C3216X7R271KQP	1V, 1kHz	270	pF	±10%	1.25	±0.30	±0.20	2.5%		(I)
	C3216X7R331KQPSG	C3216X7R331KQP	1V, 1kHz	330	pF	±10%	1.25	±0.30	±0.20	2.5%		(I)
	C3216X7R391KQPSG	C3216X7R391KQP	1V, 1kHz	390	pF	±10%	1.25	±0.30	±0.20	2.5%		(I)
	C3216X7R471KQPSG	C3216X7R471KQP	1V, 1kHz	470	pF	±10%	1.25	±0.30	±0.20	2.5%		(I)
	C3216X7R561KQPSG	C3216X7R561KQP	1V, 1kHz	560	pF	±10%	1.25	±0.30	±0.20	2.5%		(I)
	C3216X7R681KQPSG	C3216X7R681KQP	1V, 1kHz	680	pF	±10%	1.25	±0.30	±0.20	2.5%		(I)
	C3216X7R821KQPSG	C3216X7R821KQP	1V, 1kHz	820	pF	±10%	1.25	±0.30	±0.20	2.5%	(I)	
	C3216X7R102□QPSG	C3216X7R102□QP	1V, 1kHz	1.0	nF	±5%, ±10%, ±20%	1.25	±0.30	±0.20	2.5%	Embossed, 3Kpcs	(I)
	C3216X7R122KQPSG		1V, 1kHz	1.2	nF	±10%	1.25	±0.30	±0.20	2.5%	Embossed, 3Kpcs	(I)
	C3216X7R122KQPSL	C3216X7R122KQP	1V, 1kHz	1.2	nF	±10%	1.60	±0.30	±0.20	2.5%	Embossed, 2Kpcs	(I)
	C3216X7R152KQPSG		1V, 1kHz	1.5	nF	±10%	1.25	±0.30	±0.20	2.5%	Embossed, 3Kpcs	(I)
	C3216X7R152KQPSL	C3216X7R152KQP	1V, 1kHz	1.5	nF	±10%	1.60	±0.30	±0.20	2.5%	Embossed, 2Kpcs	(I)
	C3216X7R182KQPSG		1V, 1kHz	1.8	nF	±10%	1.25	±0.30	±0.20	2.5%	Embossed, 3Kpcs	(I)
	C3216X7R182KQPSL	C3216X7R182KQP	1V, 1kHz	1.8	nF	±10%	1.60	±0.30	±0.20	2.5%	Embossed, 2Kpcs	(I)
	C3216X7R222□QPSG		1V, 1kHz	2.2	nF	±10%, ±20%	1.25	±0.30	±0.20	2.5%	Embossed, 3Kpcs	(I)
	C3216X7R222□QPSL	C3216X7R222□QP	1V, 1kHz	2.2	nF	±10%, ±20%	1.60	±0.30	±0.20	2.5%	Embossed, 2Kpcs	(I)
C3216X7R332KQPSG	C3216X7R332KQP	1V, 1kHz	3.3	nF	±10%	1.25	±0.30	±0.20	2.5%	Embossed, 3Kpcs	(I)	
C3216X7R472□QPSL	C3216X7R472□QP	1V, 1kHz	4.7	nF	±10%, ±20%	1.60	±0.30	±0.20	2.5%	Embossed, 2Kpcs	(I)	

□ Tolerance Code: J=±5%, K=±10%, M=±20%; Special tolerance on the request.

RV	DARFON P/N	DARFON P/N 2	Measuring Condition	Capacitance		Available Tolerance	Thick. (mm)	Tolerance(mm)		DF (max.)	Standard Packing	Test Spec.		
				Value	Unit			L/W	Thick.					
1000V	C3216X7R101□PPSG	C3216X7R101□PP	1V, 1kHz	100	pF	±5%, ±10%	1.25	±0.30	±0.20	2.5%	Embossed, 3Kpcs	(I)		
	C3216X7R151KPPSG	C3216X7R151KPP	1V, 1kHz	150	pF	±10%	1.25	±0.30	±0.20	2.5%		(I)		
	C3216X7R181KPPSG	C3216X7R181KPP	1V, 1kHz	180	pF	±10%	1.25	±0.30	±0.20	2.5%		(I)		
	C3216X7R221KPPSG	C3216X7R221KPP	1V, 1kHz	220	pF	±10%	1.25	±0.30	±0.20	2.5%		(I)		
	C3216X7R271KPPSG	C3216X7R271KPP	1V, 1kHz	270	pF	±10%	1.25	±0.30	±0.20	2.5%		(I)		
	C3216X7R331KPPSG	C3216X7R331KPP	1V, 1kHz	330	pF	±10%	1.25	±0.30	±0.20	2.5%		(I)		
	C3216X7R391KPPSG	C3216X7R391KPP	1V, 1kHz	390	pF	±10%	1.25	±0.30	±0.20	2.5%		(I)		
	C3216X7R471KPPSG	C3216X7R471KPP	1V, 1kHz	470	pF	±10%	1.25	±0.30	±0.20	2.5%		(I)		
	C3216X7R561KPPSG	C3216X7R561KPP	1V, 1kHz	560	pF	±10%	1.25	±0.30	±0.20	2.5%		(I)		
	C3216X7R681KPPSG	C3216X7R681KPP	1V, 1kHz	680	pF	±10%	1.25	±0.30	±0.20	2.5%		(I)		
	C3216X7R821KPPSG	C3216X7R821KPP	1V, 1kHz	820	pF	±10%	1.25	±0.30	±0.20	2.5%		(I)		
	C3216X7R102□PPSG	C3216X7R102□PP	1V, 1kHz	1.0	nF	±5%, ±10%	1.25	±0.30	±0.20	2.5%		(I)		
	C3216X7R122KPPSG	C3216X7R122KPP	1V, 1kHz	1.2	nF	±10%	1.25	±0.30	±0.20	2.5%		(I)		
	C3216X7R152KPPSG	C3216X7R152KPP	1V, 1kHz	1.5	nF	±10%	1.25	±0.30	±0.20	2.5%		(I)		
	C3216X7R182KPPSG	C3216X7R182KPP	1V, 1kHz	1.8	nF	±10%	1.25	±0.30	±0.20	2.5%		(I)		
	C3216X7R222KPPSG	C3216X7R222KPP	1V, 1kHz	2.2	nF	±10%	1.25	±0.30	±0.20	2.5%		(I)		
	C3216X7R272KPPSG	C3216X7R272KPP	1V, 1kHz	2.7	nF	±10%	1.25	±0.30	±0.20	2.5%		(I)		
	C3216X7R332KPPSG	C3216X7R332KPP	1V, 1kHz	3.3	nF	±10%	1.25	±0.30	±0.20	2.5%		(I)		
	C3216X7R392KPPSG	C3216X7R392KPP	1V, 1kHz	3.9	nF	±10%	1.25	±0.30	±0.20	2.5%		(I)		
	C3216X7R472KPPSG	C3216X7R472KPP	1V, 1kHz	4.7	nF	±10%	1.25	±0.30	±0.20	2.5%		(I)		
	C3216X7R562KPPSG	C3216X7R562KPP	1V, 1kHz	5.6	nF	±10%	1.25	±0.30	±0.20	2.5%		(I)		
	C3216X7R682KPPSG	C3216X7R682KPP	1V, 1kHz	6.8	nF	±10%	1.25	±0.30	±0.20	2.5%		(I)		
	C3216X7R822KPPSG	C3216X7R822KPP	1V, 1kHz	8.2	nF	±10%	1.25	±0.30	±0.20	2.5%		(I)		
	C3216X7R103KPPSG	C3216X7R103KPP	1V, 1kHz	10	nF	±10%	1.25	±0.30	±0.20	2.5%		(I)		
	C3216X7R103KPPSL		1V, 1kHz	10	nF	±10%	1.60	±0.30	±0.20	2.5%		Embossed, 2Kpcs	(I)	
	630V	C3216X7R101KMPSG	C3216X7R101KMP	1V, 1kHz	100	pF	±10%	1.25	±0.15	±0.20		2.5%	Embossed, 3Kpcs	(II)
		C3216X7R181KMTSE	C3216X7R181KMT	1V, 1kHz	180	pF	±10%	0.85	±0.15	±0.15		2.5%	Paper, 4Kpcs	(I)
		C3216X7R181KMPSG	C3216X7R181KMP	1V, 1kHz	180	pF	±10%	1.25	±0.15	±0.20		2.5%	Embossed, 3Kpcs	(II)
		C3216X7R221KMTSE	C3216X7R221KMT	1V, 1kHz	220	pF	±10%	0.85	±0.15	±0.15		2.5%	Paper, 4Kpcs	(I)
		C3216X7R221KMPSG	C3216X7R221KMP	1V, 1kHz	220	pF	±10%	1.25	±0.15	±0.20		2.5%	Embossed, 3Kpcs	(II)
		C3216X7R271KMTSE	C3216X7R271KMT	1V, 1kHz	270	pF	±10%	0.85	±0.15	±0.15		2.5%	Paper, 4Kpcs	(I)
		C3216X7R271KMPSG	C3216X7R271KMP	1V, 1kHz	270	pF	±10%	1.25	±0.15	±0.20		2.5%	Embossed, 3Kpcs	(II)
		C3216X7R331KMTSE	C3216X7R331KMT	1V, 1kHz	330	pF	±10%	0.85	±0.15	±0.15		2.5%	Paper, 4Kpcs	(I)
C3216X7R331KMPSG		C3216X7R331KMP	1V, 1kHz	330	pF	±10%	1.25	±0.15	±0.20	2.5%	Embossed, 3Kpcs	(II)		
C3216X7R391KMTSE		C3216X7R391KMT	1V, 1kHz	390	pF	±10%	0.85	±0.15	±0.15	2.5%	Paper, 4Kpcs	(I)		
C3216X7R391KMPSG		C3216X7R391KMP	1V, 1kHz	390	pF	±10%	1.25	±0.15	±0.20	2.5%	Embossed, 3Kpcs	(II)		
C3216X7R471KMTSE		C3216X7R471KMT	1V, 1kHz	470	pF	±10%	0.85	±0.15	±0.15	2.5%	Paper, 4Kpcs	(I)		
C3216X7R471KMPSG		C3216X7R471KMP	1V, 1kHz	470	pF	±10%	1.25	±0.15	±0.20	2.5%	Embossed, 3Kpcs	(II)		
C3216X7R561KMTSE		C3216X7R561KMT	1V, 1kHz	560	pF	±10%	0.85	±0.15	±0.15	2.5%	Paper, 4Kpcs	(I)		
C3216X7R561KMPSG		C3216X7R561KMP	1V, 1kHz	560	pF	±10%	1.25	±0.15	±0.20	2.5%	Embossed, 3Kpcs	(II)		
C3216X7R681KMTSE		C3216X7R681KMT	1V, 1kHz	680	pF	±10%	0.85	±0.15	±0.15	2.5%	Paper, 4Kpcs	(I)		
C3216X7R681KMPSG		C3216X7R681KMP	1V, 1kHz	680	pF	±10%	1.25	±0.15	±0.20	2.5%	Embossed, 3Kpcs	(II)		
C3216X7R821KMTSE		C3216X7R821KMT	1V, 1kHz	820	pF	±10%	0.85	±0.15	±0.15	2.5%	Paper, 4Kpcs	(I)		
C3216X7R821KMPSG		C3216X7R821KMP	1V, 1kHz	820	pF	±10%	1.25	±0.15	±0.20	2.5%	Embossed, 3Kpcs	(II)		
C3216X7R102KMTSE		C3216X7R102KMT	1V, 1kHz	1.0	nF	±10%	0.85	±0.15	±0.15	2.5%	Paper, 4Kpcs	(I)		
C3216X7R102KMPSG		C3216X7R102KMP	1V, 1kHz	1.0	nF	±10%	1.25	±0.15	±0.20	2.5%	Embossed, 3Kpcs	(II)		
C3216X7R122KMPSG		C3216X7R122KMP	1V, 1kHz	1.2	nF	±10%	1.25	±0.15	±0.20	2.5%	Embossed, 3Kpcs	(II)		
C3216X7R152KMPSG		C3216X7R152KMP	1V, 1kHz	1.5	nF	±10%	1.25	±0.15	±0.20	2.5%	Embossed, 3Kpcs	(II)		
C3216X7R182KMPSG		C3216X7R182KMP	1V, 1kHz	1.8	nF	±10%	1.25	±0.15	±0.20	2.5%	Embossed, 3Kpcs	(II)		
C3216X7R222KMPSG		C3216X7R222KMP	1V, 1kHz	2.2	nF	±10%	1.25	±0.15	±0.20	2.5%	Embossed, 3Kpcs	(II)		
C3216X7R272KMPSG		C3216X7R272KMP	1V, 1kHz	2.7	nF	±10%	1.25	±0.15	±0.20	2.5%	Embossed, 3Kpcs	(II)		
C3216X7R332KMPSG		C3216X7R332KMP	1V, 1kHz	3.3	nF	±10%	1.25	±0.15	±0.20	2.5%	Embossed, 3Kpcs	(II)		
C3216X7R392KMPSG		C3216X7R392KMP	1V, 1kHz	3.9	nF	±10%	1.25	±0.15	±0.20	2.5%	Embossed, 3Kpcs	(II)		
C3216X7R472KMTSE		C3216X7R472KMT	1V, 1kHz	4.7	nF	±10%	0.85	±0.15	±0.15	2.5%	Paper, 4Kpcs	(I)		
C3216X7R472KMPSG		C3216X7R472KMP	1V, 1kHz	4.7	nF	±10%	1.25	±0.15	±0.20	2.5%	Embossed, 3Kpcs	(II)		
C3216X7R562KMPSG		C3216X7R562KMP	1V, 1kHz	5.6	nF	±10%	1.25	±0.15	±0.20	2.5%	Embossed, 3Kpcs	(II)		
C3216X7R682KMPSG		C3216X7R682KMP	1V, 1kHz	6.8	nF	±10%	1.25	±0.15	±0.20	2.5%	Embossed, 3Kpcs	(II)		
C3216X7R822KMPSG		C3216X7R822KMP	1V, 1kHz	8.2	nF	±10%	1.25	±0.15	±0.20	2.5%	Embossed, 3Kpcs	(II)		
C3216X7R103KMPSG	C3216X7R103KMP	1V, 1kHz	10	nF	±10%	1.25	±0.15	±0.20	2.5%	Embossed, 3Kpcs	(II)			
C3216X7R123KMPSG	C3216X7R123KMP	1V, 1kHz	12	nF	±10%	1.25	±0.15	±0.20	2.5%	Embossed, 3Kpcs	(II)			
C3216X7R123KMPSL		1V, 1kHz	12	nF	±10%	1.60	±0.30/±0.20	±0.20	2.5%	Embossed, 2Kpcs	(II)			
C3216X7R153KMPSG	C3216X7R153KMP	1V, 1kHz	15	nF	±10%	1.25	±0.15	±0.20	2.5%	Embossed, 3Kpcs	(II)			
C3216X7R153KMPSL		1V, 1kHz	15	nF	±10%	1.60	±0.30/±0.20	±0.20	2.5%	Embossed, 2Kpcs	(II)			
C3216X7R183KMPSG	C3216X7R183KMP	1V, 1kHz	18	nF	±10%	1.25	±0.15	±0.20	2.5%	Embossed, 3Kpcs	(II)			
C3216X7R183KMPSL		1V, 1kHz	18	nF	±10%	1.60	±0.30/±0.20	±0.20	2.5%	Embossed, 2Kpcs	(II)			
C3216X7R223KMPSL	C3216X7R223KMP	1V, 1kHz	22	nF	±10%	1.60	±0.30/±0.20	±0.20	2.5%	Embossed, 2Kpcs	(II)			
C3216X7R273KMPSL	C3216X7R273KMP	1V, 1kHz	27	nF	±10%	1.60	±0.30/±0.20	±0.20	2.5%	Embossed, 2Kpcs	(II)			
C3216X7R333KMPSL	C3216X7R333KMP	1V, 1kHz	33	nF	±10%	1.60	±0.30/±0.20	±0.20	2.5%	Embossed, 2Kpcs	(II)			
C3216X7R473KMPSL	C3216X7R473KMP	1V, 1kHz	47	nF	±10%	1.60	±0.30/±0.20	±0.20	2.5%	Embossed, 2Kpcs	(II)			

□ Tolerance Code: J=±5%, K=±10%, M=±20%; Special tolerance on the request.

RV	DARFON P/N	DARFON P/N 2	Measuring Condition	Capacitance		Available Tolerance	Thick. (mm)	Tolerance(mm)		DF (max.)	Standard Packing	Test Spec.
				Value	Unit			L/W	Thick.			
500V	C3216X7R101KLPSPG	C3216X7R101KLP	1V, 1kHz	100	pF	±10%	1.25	±0.15	±0.20	2.5%	Embossed, 3Kpcs	(I)
	C3216X7R181KLTSE	C3216X7R181KLT	1V, 1kHz	180	pF	±10%	0.85	±0.15	±0.15	2.5%	Paper, 4Kpcs	(I)
	C3216X7R181KLPSPG	C3216X7R181KLP	1V, 1kHz	180	pF	±10%	1.25	±0.15	±0.20	2.5%	Embossed, 3Kpcs	(I)
	C3216X7R221KLTSE	C3216X7R221KLT	1V, 1kHz	220	pF	±10%	0.85	±0.15	±0.15	2.5%	Paper, 4Kpcs	(I)
	C3216X7R221KLPSPG	C3216X7R221KLP	1V, 1kHz	220	pF	±10%	1.25	±0.15	±0.20	2.5%	Embossed, 3Kpcs	(I)
	C3216X7R471KLTSE	C3216X7R471KLT	1V, 1kHz	470	pF	±10%	0.85	±0.15	±0.15	2.5%	Paper, 4Kpcs	(I)
	C3216X7R471KLPSPG	C3216X7R471KLP	1V, 1kHz	470	pF	±10%	1.25	±0.15	±0.20	2.5%	Embossed, 3Kpcs	(I)
	C3216X7R561KLPSPG	C3216X7R561KLP	1V, 1kHz	560	pF	±10%	1.25	±0.15	±0.20	2.5%	Embossed, 3Kpcs	(II)
	C3216X7R102KLTSE	C3216X7R102KLT	1V, 1kHz	1.0	nF	±10%	0.85	±0.15	±0.15	2.5%	Paper, 4Kpcs	(I)
	C3216X7R102KLPSPG	C3216X7R102KLP	1V, 1kHz	1.0	nF	±10%	1.25	±0.15	±0.20	2.5%	Embossed, 3Kpcs	(I)
	C3216X7R222□LPSPG	C3216X7R222□LP	1V, 1kHz	2.2	nF	±10%, ±20%	1.25	±0.15	±0.20	2.5%	Embossed, 3Kpcs	(I)
	C3216X7R272KLPSPG	C3216X7R272KLP	1V, 1kHz	2.7	nF	±10%	1.25	±0.15	±0.20	2.5%		(I)
	C3216X7R332KLPSPG	C3216X7R332KLP	1V, 1kHz	3.3	nF	±10%	1.25	±0.15	±0.20	2.5%		(I)
	C3216X7R392KLPSPG	C3216X7R392KLP	1V, 1kHz	3.9	nF	±10%	1.25	±0.15	±0.20	2.5%		(I)
	C3216X7R472KLPSPG	C3216X7R472KLP	1V, 1kHz	4.7	nF	±10%	1.25	±0.15	±0.20	2.5%		(I)
	C3216X7R682KLPSPG	C3216X7R682KLP	1V, 1kHz	6.8	nF	±10%	1.25	±0.15	±0.20	2.5%		(I)
C3216X7R103KLPSPG	C3216X7R103KLP	1V, 1kHz	10	nF	±10%	1.25	±0.15	±0.20	2.5%	(I)		
C3216X7R223KLPSPG	C3216X7R223KLP	1V, 1kHz	22	nF	±10%	1.60	±0.30/±0.20	±0.20	2.5%	Embossed, 2Kpcs	(I)	
C3216X7R473KLPSPG	C3216X7R473KLP	1V, 1kHz	47	nF	±10%	1.60	±0.30/±0.20	±0.20	2.5%		(I)	
250V	C3216X7R181KKPSG	C3216X7R181KKP	1V, 1kHz	180	pF	±10%	1.25	±0.15	±0.20	2.5%	Embossed, 3Kpcs	(I)
	C3216X7R221KKTSE	C3216X7R221KKT	1V, 1kHz	220	pF	±10%	0.85	±0.15	±0.15	2.5%	Paper, 4Kpcs	(I)
	C3216X7R221KKPSG	C3216X7R221KKP	1V, 1kHz	220	pF	±10%	1.25	±0.15	±0.20	2.5%	Embossed, 3Kpcs	(I)
	C3216X7R471KKTSE	C3216X7R471KKT	1V, 1kHz	470	pF	±10%	0.85	±0.15	±0.15	2.5%	Paper, 4Kpcs	(I)
	C3216X7R471KKPSG	C3216X7R471KKP	1V, 1kHz	470	pF	±10%	1.25	±0.15	±0.20	2.5%	Embossed, 3Kpcs	(I)
	C3216X7R561KKTSE	C3216X7R561KKT	1V, 1kHz	560	pF	±10%	0.85	±0.15	±0.15	2.5%	Paper, 4Kpcs	(I)
	C3216X7R561KKPSG	C3216X7R561KKP	1V, 1kHz	560	pF	±10%	1.25	±0.15	±0.20	2.5%	Embossed, 3Kpcs	(I)
	C3216X7R102KKTSE	C3216X7R102KKT	1V, 1kHz	1.0	nF	±10%	0.85	±0.15	±0.15	2.5%	Paper, 4Kpcs	(I)
	C3216X7R102KKPSG	C3216X7R102KKP	1V, 1kHz	1.0	nF	±10%	1.25	±0.15	±0.20	2.5%	Embossed, 3Kpcs	(I)
	C3216X7R222KKTSE	C3216X7R222KKT	1V, 1kHz	2.2	nF	±10%	0.85	±0.15	±0.15	2.5%	Paper, 4Kpcs	(I)
	C3216X7R222KKPSG	C3216X7R222KKP	1V, 1kHz	2.2	nF	±10%	1.25	±0.15	±0.20	2.5%	Embossed, 3Kpcs	(I)
	C3216X7R472KKTSE	C3216X7R472KKT	1V, 1kHz	4.7	nF	±10%	0.85	±0.15	±0.15	2.5%	Paper, 4Kpcs	(I)
	C3216X7R472KKPSG	C3216X7R472KKP	1V, 1kHz	4.7	nF	±10%	1.25	±0.15	±0.20	2.5%	Embossed, 3Kpcs	(I)
	C3216X7R103□KTSE	C3216X7R103□KT	1V, 1kHz	10	nF	±5%, ±10%	0.85	±0.15	±0.15	2.5%	Paper, 4Kpcs	(I)
	C3216X7R103KKPSG	C3216X7R103KKP	1V, 1kHz	10	nF	±10%	1.25	±0.15	±0.20	2.5%	Embossed, 3Kpcs	(I)
	C3216X7R153KKPSG	C3216X7R153KKP	1V, 1kHz	15	nF	±10%	1.25	±0.15	±0.20	2.5%		(I)
C3216X7R223KKPSG	C3216X7R223KKP	1V, 1kHz	22	nF	±10%	1.25	±0.15	±0.20	2.5%	Embossed, 2Kpcs	(II)	
C3216X7R333KKPSL	C3216X7R333KKP	1V, 1kHz	33	nF	±10%	1.60	±0.30/±0.20	±0.20	2.5%		(I)	
C3216X7R473KKPSG		1V, 1kHz	47	nF	±10%	1.25	±0.15	±0.20	2.5%	Embossed, 3Kpcs	(I)	
C3216X7R473KKPSL	C3216X7R473KKP	1V, 1kHz	47	nF	±10%	1.60	±0.20	±0.20	2.5%	Embossed, 2Kpcs	(I)	
C3216X7R104KKPSL	C3216X7R104KKP	1V, 1kHz	100	nF	±10%	1.60	±0.20	±0.20	2.5%		(I)	
C3216X7R224KKPSL	C3216X7R224KKP	1V, 1kHz	220	nF	±10%	1.60	±0.20	±0.20	2.5%	(I)		
200V	C3216X7R221KJTSE	C3216X7R221KJT	1V, 1kHz	220	pF	±10%	0.85	±0.15	±0.15	2.5%	Paper, 4Kpcs	(I)
	C3216X7R821KJTSE	C3216X7R821KJT	1V, 1kHz	820	pF	±10%	0.85	±0.15	±0.15	2.5%		(I)
	C3216X7R102KJTSE	C3216X7R102KJT	1V, 1kHz	1.0	nF	±10%	0.85	±0.15	±0.15	2.5%		(I)
	C3216X7R102KJPSPG	C3216X7R102KJP	1V, 1kHz	1.0	nF	±10%	1.25	±0.15	±0.20	2.5%	Embossed, 3Kpcs	(I)
	C3216X7R222□JTSE	C3216X7R222□JT	1V, 1kHz	2.2	nF	±5%, ±10%	0.85	±0.15	±0.15	2.5%	Paper, 4Kpcs	(I)
	C3216X7R332KJTSE	C3216X7R332KJT	1V, 1kHz	3.3	nF	±10%	0.85	±0.15	±0.15	2.5%	Paper, 4Kpcs	(I)
	C3216X7R332KJPSPG	C3216X7R332KJP	1V, 1kHz	3.3	nF	±10%	1.25	±0.15	±0.20	2.5%	Embossed, 3Kpcs	(I)
	C3216X7R103□JPSPG	C3216X7R103□JP	1V, 1kHz	10	nF	±10%, ±20%	1.25	±0.15	±0.20	2.5%		(I)
	C3216X7R473KJPSPG		1V, 1kHz	47	nF	±10%	1.25	±0.15	±0.20	2.5%	Embossed, 2Kpcs	(I)
	C3216X7R473KJPSPG	C3216X7R473KJP	1V, 1kHz	47	nF	±10%	1.60	±0.20	±0.20	2.5%		(I)
C3216X7R683KJPSPG	C3216X7R683KJP	1V, 1kHz	68	nF	±10%	1.60	±0.20	±0.20	2.5%	Embossed, 2Kpcs	(I)	
C3216X7R104KJPSPG	C3216X7R104KJP	1V, 1kHz	100	nF	±10%	1.60	±0.20	±0.20	2.5%		(I)	

MLCC
Middle High Voltage

RV	DARFON P/N	DARFON P/N 2	Measuring Condition	Capacitance		Available Tolerance	Thick. (mm)	Tolerance(mm)		DF (max.)	Standard Packing	Test Spec.
				Value	Unit			L/W	Thick.			
100V	C3216X7R101JHTSD	C3216X7R101JHT	1V, 1kHz	100.0	pF	±5%	0.80	±0.15	±0.10	2.5%	Paper, 4Kpcs	(I)
	C3216X7R102□HTSE	C3216X7R102□HT	1V, 1kHz	1.0	nF	±5%, ±10%	0.85	±0.15	±0.15	2.5%	Paper, 4Kpcs	(II)
	C3216X7R102KHPSG	C3216X7R102KHPP	1V, 1kHz	1.0	nF	±10%	1.25	±0.15	±0.20	2.5%	Embossed, 3Kpcs	(I)
	C3216X7R222KHHTSE	C3216X7R222KHHT	1V, 1kHz	2.2	nF	±10%	0.85	±0.15	±0.15	2.5%	Paper, 4Kpcs	(I)
	C3216X7R472KHHTSE	C3216X7R472KHHT	1V, 1kHz	4.7	nF	±10%	0.85	±0.15	±0.15	2.5%		(II)
	C3216X7R103KHHTSD	C3216X7R103KHHT	1V, 1kHz	10	nF	±10%	0.80	±0.15	±0.10	3.5%	Paper, 4Kpcs	(I)
	C3216X7R123KHHTSD	C3216X7R123KHHT	1V, 1kHz	12	nF	±10%	0.80	±0.15	±0.10	3.5%	(II)	
	C3216X7R123KHPSG	C3216X7R123KHPP	1V, 1kHz	12	nF	±10%	1.25	±0.15	±0.20	3.5%	Embossed, 3Kpcs	(I)
	C3216X7R153KHHTSD	C3216X7R153KHHT	1V, 1kHz	15	nF	±10%	0.80	±0.15	±0.10	3.5%	Paper, 4Kpcs	(I)
	C3216X7R153KHPSG	C3216X7R153KHPP	1V, 1kHz	15	nF	±10%	1.25	±0.15	±0.20	3.5%	Embossed, 3Kpcs	(I)
	C3216X7R183KHHTSD	C3216X7R183KHHT	1V, 1kHz	18	nF	±10%	0.80	±0.15	±0.10	3.5%	Paper, 4Kpcs	(I)
	C3216X7R183KHPSG	C3216X7R183KHPP	1V, 1kHz	18	nF	±10%	1.25	±0.15	±0.20	3.5%	Embossed, 3Kpcs	(I)
	C3216X7R223KHHTSD	C3216X7R223KHHT	1V, 1kHz	22	nF	±10%	0.80	±0.15	±0.10	3.5%	Paper, 4Kpcs	(I)
	C3216X7R273KHHTSD	C3216X7R273KHHT	1V, 1kHz	27	nF	±10%	0.80	±0.15	±0.10	3.5%		(II)
	C3216X7R333KHHTSD	C3216X7R333KHHT	1V, 1kHz	33	nF	±10%	0.80	±0.15	±0.10	3.5%	Paper, 4Kpcs	(I)
	C3216X7R393KHHTSD	C3216X7R393KHHT	1V, 1kHz	39	nF	±10%	0.80	±0.15	±0.10	3.5%	(II)	
	C3216X7R473KHHTSD	C3216X7R473KHHT	1V, 1kHz	47	nF	±10%	0.80	±0.15	±0.10	3.5%	Paper, 4Kpcs	(I)
	C3216X7R473KHPSG	C3216X7R473KHPP	1V, 1kHz	47	nF	±10%	1.25	±0.15	±0.20	3.5%	Embossed, 3Kpcs	(I)
	C3216X7R563KHHTSD	C3216X7R563KHHT	1V, 1kHz	56	nF	±10%	0.80	±0.15	±0.10	3.5%	Paper, 4Kpcs	(I)
	C3216X7R683KHHTSD	C3216X7R683KHHT	1V, 1kHz	68	nF	±10%	0.80	±0.15	±0.10	3.5%	Paper, 4Kpcs	(I)
	C3216X7R823KHHTSD	C3216X7R823KHHT	1V, 1kHz	82	nF	±10%	0.80	±0.15	±0.10	3.5%		(II)
	C3216X7R823KHPSG	C3216X7R823KHPP	1V, 1kHz	82	nF	±10%	1.25	±0.15	±0.20	3.5%	Embossed, 3Kpcs	(I)
	C3216X7R104KHHTSD	C3216X7R104KHHT	1V, 1kHz	100	nF	±10%	0.80	±0.15	±0.10	3.5%	Paper, 4Kpcs	(I)
	C3216X7R104KHPSG	C3216X7R104KHPP	1V, 1kHz	100	nF	±10%	1.25	±0.15	±0.20	3.5%	Embossed, 3Kpcs	(I)
	C3216X7R154KHPSL	C3216X7R154KHPP	1V, 1kHz	150	nF	±10%	1.60	±0.20	±0.20	2.5%	Embossed, 2Kpcs	(I)
	C3216X7R224KHPSL	C3216X7R224KHPP	1V, 1kHz	220	nF	±10%	1.60	±0.20	±0.20	2.5%		(II)
	C3216X7R334□HPSL	C3216X7R334□HPP	1V, 1kHz	330	nF	±10%, ±20%	1.60	±0.30/±0.20	±0.20	3.0%	Embossed, 2Kpcs	(I)
	C3216X7R474KHPSL	C3216X7R474KHPP	1V, 1kHz	470	nF	±10%	1.60	±0.20	±0.20	3.0%		(II)
C3216X7R684KHPSL	C3216X7R684KHPP	1V, 1kHz	680	nF	±10%	1.60	±0.20	±0.20	3.5%	Paper, 4Kpcs	(I)	
C3216X7R105□HPSL	C3216X7R105□HPP	1V, 1kHz	1.0	uF	±10%, ±20%	1.60	±0.30	±0.30	10.0%	Embossed, 2Kpcs	(I)	
C3216X7R225KHPSL	C3216X7R225KHPP	1V, 1kHz	2.2	uF	±10%	1.60	±0.30	±0.30	10.0%		(II)	
C3216X7R475KHPSL	C3216X7R475KHPP	1V, 1kHz	4.7	uF	±10%	1.60	±0.30	±0.30	10.0%	Paper, 4Kpcs	(II)	

● C3225X7R Series (EIA1210)

RV	DARFON P/N	DARFON P/N 2	Measuring Condition	Capacitance		Available Tolerance	Thick. (mm)	Tolerance(mm)		DF (max.)	Standard Packing	Test Spec.
				Value	Unit			L/W	Thick.			
2000V	C3225X7R272□QPSP	C3225X7R272□QP	1V, 1kHz	2.7	nF	±10%, ±20%	2.50	±0.40/±0.30	±0.30	2.5%	Embossed, 1Kpcs	(I)
	C3225X7R472□QPSP	C3225X7R472□QP	1V, 1kHz	4.7	nF	±10%, ±20%	2.50	±0.40/±0.30	±0.30	2.5%	Embossed, 1Kpcs	(I)
1000V	C3225X7R103KPPSL	C3225X7R103KPP	1V, 1kHz	10	nF	±10%	1.60	±0.40/±0.30	±0.20	2.5%	Embossed, 2Kpcs	(I)
	C3225X7R223KPPSL	C3225X7R223KPP	1V, 1kHz	22	nF	±10%	1.60	±0.40/±0.30	±0.20	2.5%		(II)
630V	C3225X7R333KPPSL	C3225X7R333KPP	1V, 1kHz	33	nF	±10%	1.60	±0.40/±0.30	±0.20	2.5%	Embossed, 3Kpcs	(I)
	C3225X7R102KMPSG	C3225X7R102KMP	1V, 1kHz	1.0	nF	±10%	1.25	±0.30/±0.20	±0.20	2.5%		(II)
500V	C3225X7R223KMPSG	C3225X7R223KMP	1V, 1kHz	22	nF	±10%	1.25	±0.30/±0.20	±0.20	2.5%	Embossed, 2Kpcs	(I)
	C3225X7R683KMPSL	C3225X7R683KMP	1V, 1kHz	68	nF	±10%	1.60	±0.40/±0.30	±0.20	2.5%		(II)
250V	C3225X7R103KLPSG	C3225X7R103KLP	1V, 1kHz	10	nF	±10%	1.25	±0.30/±0.20	±0.20	2.5%	Embossed, 3Kpcs	(I)
	C3225X7R223KLPSG	C3225X7R223KLP	1V, 1kHz	22	nF	±10%	1.25	±0.30/±0.20	±0.20	2.5%		(II)
200V	C3225X7R274KKPSP	C3225X7R274KKP	1V, 1kHz	270	nF	±10%	2.50	±0.40/±0.30	±0.30	2.5%	Embossed, 1Kpcs	(I)
	C3225X7R223KJPSP	C3225X7R223KJP	1V, 1kHz	22	nF	±10%	1.25	±0.30/±0.20	±0.20	2.5%		(II)
100V	C3225X7R473KHPSSE	C3225X7R473KHPP	1V, 1kHz	47	nF	±10%	0.85	±0.20	±0.10	2.5%	Embossed, 4Kpcs	(I)
	C3225X7R224KHPSG	C3225X7R224KHPP	1V, 1kHz	220	nF	±10%	1.25	±0.30/±0.20	±0.20	2.5%		Embossed, 3Kpcs
	C3225X7R474KHPSL	C3225X7R474KHPP	1V, 1kHz	470	nF	±10%	2.50	±0.30/±0.20	±0.30	3.0%	Embossed, 1Kpcs	(I)
	C3225X7R564KHPSL	C3225X7R564KHPP	1V, 1kHz	560	nF	±10%	2.50	±0.30/±0.20	±0.30	3.0%		(II)
	C3225X7R824KHWSN	C3225X7R824KHWP	1V, 1kHz	820	nF	±10%	2.00	±0.40/±0.30	±0.20	3.0%	Embossed, 2Kpcs	(I)
	C3225X7R105KHPSN	C3225X7R105KHPP	1V, 1kHz	1.0	uF	±10%	2.00	±0.30/±0.20	±0.20	10.0%		(II)
	C3225X7R225KHPSL	C3225X7R225KHPP	1V, 1kHz	2.2	uF	±10%	2.50	±0.30/±0.20	±0.20	5.0%	Embossed, 1Kpcs	(I)
	C3225X7R475KHPSL	C3225X7R475KHPP	1V, 1kHz	4.7	uF	±10%	2.50	±0.30	±0.30	10.0%	Embossed, 1Kpcs	(II)

● C4520X7R Series (EIA1808)

RV	DARFON P/N	DARFON P/N 2	Measuring Condition	Capacitance		Available Tolerance	Thick. (mm)	Tolerance(mm)		DF (max.)	Standard Packing	Test Spec.
				Value	Unit			L/W	Thick.			
3000V	C4520X7R102KRPSN	C4520X7R102KRPP	1V, 1kHz	1.0	nF	±10%	2.00	±0.40/±0.30	±0.20	2.5%	Embossed, 2Kpcs	(I)
	C4520X7R332KRPSN	C4520X7R332KRPP	1V, 1kHz	3.3	nF	±10%	2.00	+0.5-0.3/±0.3	±0.20	2.5%		(II)
2000V	C4520X7R102KQPSG	C4520X7R102KQP	1V, 1kHz	1.0	nF	±10%	1.25	±0.40/±0.30	±0.20	2.50%	Embossed, 3Kpcs	(I)
250V	C4520X7R471KKPSPG	C4520X7R471KKP	1V, 1kHz	470	pF	±10%	1.25	±0.40/±0.30	±0.25	2.5%	Embossed, 3Kpcs	(I)

● C4532X7R Series (EIA1812)

RV	DARFON P/N	DARFON P/N 2	Measuring Condition	Capacitance		Available Tolerance	Thick. (mm)	Tolerance(mm)		DF (max.)	Standard Packing	Test Spec.
				Value	Unit			L/W	Thick.			
3000V	C4532X7R102KRPSL		1V, 1kHz	1.0	nF	±10%	1.60	±0.4/±0.2	±0.20	2.50%	Embossed, 1Kpcs	(I)
	C4532X7R152KRPSN	C4532X7R152KRP	1V, 1kHz	1.5	nF	±10%	2.00	+0.5-0.3/±0.3	±0.20	2.5%	Embossed, 1Kpcs	(I)
	C4532X7R222KRPS	C4532X7R222KRP	1V, 1kHz	2.2	nF	±10%	2.50	+0.5-0.3/±0.4	±0.30	2.5%	Embossed, 0.5Kpcs	(I)
	C4532X7R332KRPS	C4532X7R332KRP	1V, 1kHz	3.3	nF	±10%	2.50	+0.5-0.3/±0.4	±0.30	2.5%	Embossed, 0.5Kpcs	(I)
2000V	C4532X7R222KQPSG	C4532X7R222KQP	1V, 1kHz	2.2	nF	±10%	1.25	+0.5-0.3/±0.3	±0.20	2.5%	Embossed, 1Kpcs	(I)
	C4532X7R472KQPSN	C4532X7R472KQP	1V, 1kHz	4.7	nF	±10%	2.00	+0.5-0.3/±0.3	±0.20	2.5%	Embossed, 1Kpcs	(I)
	C4532X7R103KQSP	C4532X7R103KQP	1V, 1kHz	10	nF	±10%	2.50	+0.5-0.3/±0.4	±0.30	2.5%	Embossed, 0.5Kpcs	(I)
1000V	C4532X7R472KPPSG	C4532X7R472KPP	1V, 1kHz	4.7	nF	±10%	1.25	+0.5-0.3/±0.3	±0.10	2.5%	Embossed, 1Kpcs	(I)
	C4532X7R223KPPSG	C4532X7R223KPP	1V, 1kHz	22	nF	±10%	1.25	+0.5-0.3/±0.3	±0.30	2.5%	Embossed, 1Kpcs	(II)
630V	C4532X7R683KMPSN	C4532X7R683KMP	1V, 1kHz	68	nF	±10%	2.00	+0.5-0.3/±0.3	±0.20	2.5%	Embossed, 1Kpcs	(II)
	C4532X7R104KMPSN	C4532X7R104KMP	1V, 1kHz	100	nF	±10%	2.00	+0.5-0.3/±0.3	±0.20	2.5%	Embossed, 1Kpcs	(II)
250V	C4532X7R334MKPSN		1V, 1kHz	330	nF	±20%	2.00	+0.5-0.3/±0.3	±0.20	2.5%	Embossed, 1Kpcs	(II)
	C4532X7R474KKPSL	C4532X7R474KKP	1V, 1kHz	470	nF	±10%	1.60	±0.4/±0.3	±0.20	2.5%	Embossed, 1Kpcs	(III)
100V	C4532X7R225KHWSP	C4532X7R105KHW	1V, 1kHz	2.2	uF	±10%	2.50	+0.5-0.3/±0.4	±0.30	2.5%	Embossed, 0.7Kpcs	(II)

■ X7S Series

● C1005 X7S Series (EIA0402)

RV	DARFON P/N	DARFON P/N 2	Measuring Condition	Capacitance		Available Tolerance	Thick. (mm)	Tolerance(mm)		DF (max.)	Standard Packing	Test Spec.
				Value	Unit			L/W	Thick.			
100V	C1005X7S222KHTS	C1005X7S222KHT	1V, 1kHz	2.2	nF	±10%	0.50	±0.05	±0.05	3.0%	Paper, 10Kpcs	(I)
	C1005X7S103KHTS	C1005X7S103KHT	1V, 1kHz	10	nF	±10%	0.50	±0.05	±0.05	3.0%		(I)

● C1608 X7S Series (EIA0603)

RV	DARFON P/N	DARFON P/N 2	Measuring Condition	Capacitance		Available Tolerance	Thick. (mm)	Tolerance(mm)		DF (max.)	Standard Packing	Test Spec.
				Value	Unit			L/W	Thick.			
100V	C1608X7S473KHTS	C1608X7S473KHT	1V, 1kHz	47	nF	±10%	0.80	±0.15	±0.15	3.0%	Paper, 4Kpcs	(I)
	C1608X7S104KHTS	C1608X7S104KHT	1V, 1kHz	100	nF	±10%	0.80	±0.15	±0.15	10.0%		(I)

● C2012X7S Series (EIA0805)

RV	DARFON P/N	DARFON P/N 2	Measuring Condition	Capacitance		Available Tolerance	Thick. (mm)	Tolerance(mm)		DF (max.)	Standard Packing	Test Spec.
				Value	Unit			L/W	Thick.			
100V	C2012X7S105□HPSG	C2012X7S105□HP	1V, 1kHz	1.0	uF	±10%, ±20%	1.25	± 0.20	±0.20	10.0%	Embossed, 3Kpcs	(II)

● C3216X7S Series (EIA1206)

RV	DARFON P/N	DARFON P/N 2	Measuring Condition	Capacitance		Available Tolerance	Thick. (mm)	Tolerance(mm)		DF (max.)	Standard Packing	Test Spec.
				Value	Unit			L/W	Thick.			
100V	C3216X7S225KHPSL	C3216X7S225KHP	1V, 1kHz	2.2	uF	±10%	1.60	± 0.30	±0.30	10.0%	Embossed, 2Kpcs	(II)
	C3216X7S475□HPSL	C3216X7S475□HP	1V, 1kHz	4.7	uF	±10%, ±20%	1.60	± 0.30	±0.30	10.0%	Embossed, 2Kpcs	(II)

● C3225X7S Series (EIA1210)

RV	DARFON P/N	DARFON P/N 2	Measuring Condition	Capacitance		Available Tolerance	Thick. (mm)	Tolerance(mm)		DF (max.)	Standard Packing	Test Spec.
				Value	Unit			L/W	Thick.			
100V	C3225X7S475□HPSN	C3225X7S475□HP	1V, 1kHz	4.7	uF	±10%, ±20%	2.00	± 0.30	±0.30	10.0%	Embossed, 2Kpcs	(II)
	C3225X7S475KHPS		1V, 1kHz	4.7	uF	±10%	2.50	± 0.30	±0.30	10.0%	Embossed, 1Kpcs	(II)
	C3225X7S106KHPS	C3225X7S106KHP	1V, 1kHz	10	uF	±10%	2.50	± 0.30	±0.30	10.0%	Embossed, 1Kpcs	(II)

□ Tolerance Code: K=±10%, M=±20%; Special tolerance on the request.

■ X7T Series

● C2012 X7T Series (EIA0805)

RV	DARFON P/N	DARFON P/N 2	Measuring Condition	Capacitance		Available Tolerance	Thick. (mm)	Tolerance(mm)		DF (max.)	Standard Packing	Test Spec.
				Value	Unit			L/W	Thick.			
100V	C2012X7T225KHPSG	C2012X7T225KHP	1V , 1kHz	2.2	uF	±10%	1.25	± 0.20	±0.20	10.0%	Embossed, 3Kpcs	(II)

● C3216 X7T Series (EIA1206)

RV	DARFON P/N	DARFON P/N 2	Measuring Condition	Capacitance		Available Tolerance	Thick. (mm)	Tolerance(mm)		DF (max.)	Standard Packing	Test Spec.
				Value	Unit			L/W	Thick.			
250V	C3216X7T224KKPSL	C3216X7T224KKP	1V, 1kHz	220	nF	±10%	1.60	±0.20	±0.20	2.5%	Embossed, 2Kpcs	(I)

● C3225 X7T Series (EIA1210)

RV	DARFON P/N	DARFON P/N 2	Measuring Condition	Capacitance		Available Tolerance	Thick. (mm)	Tolerance(mm)		DF (max.)	Standard Packing	Test Spec.
				Value	Unit			L/W	Thick.			
100V	C3225X7T106KHPSL	C3225X7T106KHP	1V , 1kHz	10	uF	±10%	2.50	± 0.30	±0.30	10.0%	Embossed, 1Kpcs	(II)

■ X6S Series

● C3216 X6S Series (EIA1206)

RV	DARFON P/N	DARFON P/N 2	Measuring Condition	Capacitance		Available Tolerance	Thick. (mm)	Tolerance(mm)		DF (max.)	Standard Packing	Test Spec.
				Value	Unit			L/W	Thick.			
100V	C3216X6S475KHPSL	C3216X6S475KHP	1V , 1kHz	4.7	uF	±10%	1.60	±0.30	±0.30	10.0%	Embossed, 2Kpcs	(II)

- Test Spec.
- Middle-High Voltage (I)

No	Item	Specification		Test Method																														
		Temp. compensation type	High dielectric constant type																															
1	Operation Temperature Range	NP0: -55 to 125 °C X8G: -55 to 150 °C	X5R: -55 to 85 °C X7R/X7S: -55 to 125 °C	---																														
2	Rated Voltage	Shown in the table of "Part Number & Characteristic"		The rated voltage is defined as the maximum voltage, which may be applied continuously to the capacitor.																														
3	Appearance	No defects or abnormalities.		Visual inspection																														
4	Dimensions	Within the specified dimension.		Using calipers																														
5	Dielectric Strength	No defects or abnormalities.		No failure shall be observed when 250% of the rated voltage (150% for 500V, 120% for above 1KV) is applied between the terminations for 1 to 5 seconds. The charge and discharge current is less than 50mA.																														
6	Insulation Resistance (I.R.)	Rated Voltage <200V	To apply rated voltage.	I.R. $\geq 10G\Omega$ or $R_C R_R \geq 100\Omega \cdot F$ (whichever is smaller)																														
		Rated Voltage <500V	To apply rated voltage.	I.R. $\geq 10G\Omega$ or $R_C R_R \geq 100\Omega \cdot F$ (whichever is smaller)																														
		Rated Voltage $\geq 500V$	To apply 500V.	I.R. $\geq 10G\Omega$ or $R_C R_R \geq 100\Omega \cdot F$ (whichever is smaller)																														
7	Capacitance	Within the specified tolerance * X5R/X7R/X7S at 1000 hours		The capacitance / D.F. shall be measured at 25 °C at the frequency and voltage shown in the table of "Part Number & Characteristic".																														
8	Q/Dissipation Factor (D.F.)	NP0/X8G: If $C \leq 30pF$, $DF \leq 1/(400+20C)$, C in pF If $C > 30pF$, $DF \leq 0.1\%$.	Shown in the table of "Part Number & Characteristic"																															
9	Capacitance Temperature Characteristics	Capacitance change NP0 within $0 \pm 30ppm/^\circ C$ under operating temperature range.	Capacitance change X5R/X7R within $\pm 15\%$ X7S within $\pm 22\%$	1. Temperature compensation type: The capacitance value at 25 °C and 85 °C shall be measured and calculated from the formula given below. $T.C. = (C_{85} - C_{25}) / C_{25} \cdot \Delta T \cdot 10^6 (PPM/^\circ C)$ 2. High dielectric constant type: The ranges of capacitance change compared with the 25 °C value over the temperature ranges shall be within the specified ranges.																														
10	Termination Strength	No removal of the terminations or marking defect.		Apply a parallel force of 5N to a PCB mounted sample for 10 ± 1 sec. (IEC 60384- 21/22)																														
11	Deflection (Bending Strength)	No cracking or marking defects shall occur at 1mm deflection. Capacitance change: NP0/X8G: within $\pm 5\%$ or $\pm 0.5pF$. (whichever is larger) X5R, X7R, X7S within $\pm 12.5\%$		Solder the capacitor to the test jig (glass epoxy boards) shown in Fig.a using a SAC305(Sn96.5Ag3.0Cu0.5) solder (then let sit for 24 ± 2 hours for X7R). Then apply a force in the direction shown in Fig.b. The soldering shall be done with the reflow method and shall be conducted with care so that the soldering is uniform and free of defects such as heat shock.																														
		<table border="1"> <thead> <tr> <th>Size</th> <th>a</th> <th>b</th> <th>C</th> </tr> </thead> <tbody> <tr> <td>0603</td> <td>0.3</td> <td>0.9</td> <td>0.3</td> </tr> <tr> <td>1005</td> <td>0.4</td> <td>1.5</td> <td>0.5</td> </tr> <tr> <td>1608</td> <td>1.0</td> <td>3.0</td> <td>1.2</td> </tr> <tr> <td>2012</td> <td>1.2</td> <td>4.0</td> <td>1.65</td> </tr> <tr> <td>3216</td> <td>2.2</td> <td>5.0</td> <td>2.0</td> </tr> <tr> <td>4520</td> <td>3.5</td> <td>7.0</td> <td>2.5</td> </tr> <tr> <td>4532</td> <td>3.5</td> <td>7.0</td> <td>3.7</td> </tr> </tbody> </table>		Size	a	b	C	0603	0.3	0.9	0.3	1005	0.4	1.5	0.5	1608	1.0	3.0	1.2	2012	1.2	4.0	1.65	3216	2.2	5.0	2.0	4520	3.5	7.0	2.5	4532	3.5	7.0
Size	a	b	C																															
0603	0.3	0.9	0.3																															
1005	0.4	1.5	0.5																															
1608	1.0	3.0	1.2																															
2012	1.2	4.0	1.65																															
3216	2.2	5.0	2.0																															
4520	3.5	7.0	2.5																															
4532	3.5	7.0	3.7																															
12	Solderability of Termination (Mounting)	90% of the terminations are to be soldered evenly and continuously. (The capacitors may be mounted on printed-circuit boards or ceramic substrates and no visible damage)		Immerse the test capacitor into a methanol solution containing rosin for 3 to 5 seconds, preheat it 150 to 180 °C for 2 to 3 minutes and immerse it into SAC305(Sn96.5Ag3.0Cu0.5) solder of $245 \pm 5^\circ C$ for 3 ± 1 seconds. (IEC 60384- 21/22)																														
13	Resistance to Soldering Heat	Appearance	No marking defects																															
		Cap. Change	NP0/X8G within $\pm 2.5\%$ or $0.25pF$ (whichever is larger)	X5R/X7R/X7S within $\pm 7.5\%$																														
		Q/D.F.	If $C \leq 30pF$, $DF \leq 1/(400+20C)$ If $C > 30pF$, $DF \leq 0.1\%$	To satisfy the specified initial spec.																														
		I.R.	I.R. $\geq 10,000M\Omega$ or $R_C R_R \geq 100\Omega \cdot F$. (whichever is smaller)	I.R. $\geq 10,000M\Omega$ or $R_C R_R \geq 100\Omega \cdot F$. (whichever is smaller)																														
		*Preheat the capacitor at 120 to 150 °C for 1 minute. Immerse the capacitor in a SAC305(Sn96.5Ag3.0Cu0.5) solder solution at $270 \pm 5^\circ C$ for 10 ± 1 seconds. Let sit at room temperature for 24 ± 2 hours, then measure. * Preheat 150 to 200 °C for size ≥ 3216 . *High dielectric constant type: Initial measurement : perform a heat treatment at $150 \pm 0/-10^\circ C$ for one hour and then let sit for 24 ± 2 hours at room temperature. Perform the initial measurement.																																

No	Item	Specification		Test Method	
		Temp. compensation type	High dielectric constant type		
14	Temperature cycle (Thermal shock)	Appearance	No marking defects		Solder the capacitor to supporting jig (Glass epoxy board) and perform the five cycles according to the four heat treatments listed in the following table. Let sit for 24±2hrs at room temperature, then measure. Step 1: Minimum operating temperature 30±3min Step 2: Room temperature 2-3 min Step 3: Maximum operating temperature 30±3min Step 4: Room temperature 2-3min *High dielectric constant type: Initial measurement: perform a heat treatment at 150±10°C for one hour and then let sit for 24±2 hours at room temp. Perform the initial measurement. (IEC 60384- 21/22)
		Cap. Change	NP0/X8G within ±2.5% or 0.25pF (whichever is larger)	X5R/X7R/X7S within ±7.5%	
		Q/D.F.	If C ≤ 30pF, DF ≤ 1/(400+20C) If C > 30pF, DF ≤ 0.1%	To satisfy the specified initial spec.	
		I.R.	I.R. ≥ 10,000MΩ or R _i C _R ≥ 100Ω-F. (whichever is smaller)	I.R. ≥ 10,000MΩ or R _i C _R ≥ 100Ω-F. (whichever is smaller)	
15	Humidity load	Appearance	No marking defects		Apply the rated voltage (Max. 500V) at 40±2°C and 90 to 95% humidity for 500±12 hours. The charge / discharge current is less than 50mA. [Temperature compensation type] Remove and let sit for 24±2 hours at room temperature, then measure. [High dielectric constant type] *Initial measurement Perform a heat treatment at 150+0/-10°C for one hour and then let sit for 24±2 hours at room temperature. Perform the initial measurement. *Measurement after test Perform a heat treatment and then let sit for 24±2 hours at room temperature, then measure.
		Cap. Change	NP0/X8G within ±7.5% or 0.75pF (whichever is larger)	X5R/X7R/X7S within ±12.5%	
		Q/D.F.	If C > 30pF, DF ≤ 0.5% If C ≤ 30pF, DF ≤ 1/(100+10xC/3) C in pF	X5R/X7R/X7S 200% max of initial spec.	
		I.R.	I.R. ≥ 500MΩ or R _i C _R ≥ 25Ω-F. (whichever is smaller)	I.R. ≥ 500MΩ or R _i C _R ≥ 25Ω-F. (whichever is smaller)	
16	High temperature load life test	Appearance	No marking defects		Apply 200%(150% for ≥ 500V; 120% for ≥ 1000V ; 110% for ≥ 2000V ; 100% for ≥ 3000V) of the rated voltage for 1000±12 hours at the maximum operating temperature ± 3°C. The charge / discharge current is less than 50mA. [Temperature compensation type] Remove and let sit for 24±2 hours at room temperature, then measure. [High dielectric constant type] *Initial measurement Perform a heat treatment at 150+0/-10°C for one hour and then let sit for 24±2 hours at room temperature. Perform the initial measurement. *Measurement after test Perform a heat treatment and then let sit for 24±2 hours at room temperature, then measure. (IEC 60384- 21/22)
		Cap. Change	NP0/X8G within ±7.5% or 0.75pF (whichever is larger)	X5R/X7R/X7S within ±12.5%	
		Q/D.F.	If C > 30pF, DF ≤ 0.3% If 10pF < C ≤ 30pF, DF ≤ 1/(275+5xC/2) If C ≤ 10pF, DF ≤ 1/(200+10C), C in pF	X5R/X7R/X7S 200% max of initial spec.	
		I.R.	More than 1GΩ or R _i C _R ≥ 50Ω-F (whichever is less.)	More than 1GΩ or R _i C _R ≥ 50Ω-F (whichever is less.)	

● Middle-High Voltage (II)

No	Item	Specification		Test Method																													
		Temp. compensation type	High dielectric constant type																														
1	Operation Temperature Range	NP0/X8G: -55 to 125 °C	X5R: -55 to 85 °C X7R/X7S: -55 to 125 °C	---																													
2	Rated Voltage	Shown in the table of "Part Number & Characteristic"		The rated voltage is defined as the maximum voltage, which may be applied continuously to the capacitor.																													
3	Appearance	No defects or abnormalities.		Visual inspection																													
4	Dimensions	Within the specified dimension.		Using calipers																													
5	Dielectric Strength	No defects or abnormalities.		No failure shall be observed when 250% of the rated voltage (150% for 500V, 120% for above 1KV) is applied between the terminations for 1 to 5 seconds. The charge and discharge current is less than 50mA.																													
6	Insulation Resistance (I.R.)	C ≤ 0.047μF : More than 10000 MΩ C > 0.047μF : More than 100Ω-F C: Nominal Capacitance		The insulation resistance shall be measured with a DC voltage not exceeding the rated voltage at 25°C and 75%RH max, and within 1 minute of charging.																													
7	Capacitance	Within the specified tolerance * X5R/X7R/X7S at 1000 hours		The capacitance / D.F. shall be measured at 25°C at the frequency and voltage shown in the table of "Part Number & Characteristic".																													
8	Q/Dissipation Factor (D.F.)	NP0/X8G: If C ≤ 30pF, DF ≤ 1/(400+20C), C in pF If C > 30pF, DF ≤ 0.1%.	Shown in the table of "Part Number & Characteristic"																														
9	Capacitance Temperature Characteristics	Capacitance change NP0/X8G within 0±30ppm/°C under operating temperature range.	Capacitance change X5R/X7R within ±15% X7S within ±22%	1. Temperature compensation type: The capacitance value at 25°C and 85°C shall be measured and calculated from the formula given below. T.C. = (C ₈₅ - C ₂₅) / C ₂₅ * ΔT * 10 ⁶ (PPM/°C) 2. High dielectric constant type: The ranges of capacitance change compared with the 25°C value over the temperature ranges shall be within the specified ranges.																													
10	Termination Strength	No removal of the terminations or marking defect.		Apply a parallel force of 5N to a PCB mounted sample for 10±1sec. (IEC 60384- 21/22)																													
11	Deflection (Bending Strength)	No cracking or marking defects shall occur at 1mm deflection. Capacitance change: NP0/X8G: within ±5% or ± 0.5pF. (whichever is larger) X5R, X7R, X7S :within ±12.5%		Solder the capacitor to the test jig (glass epoxy boards) shown in Fig.a using a SAC305(Sn96.5Ag3.0Cu0.5) solder (then let sit for 24±2 hours for X7R). Then apply a force in the direction shown in Fig.b. The soldering shall be done with the reflow method and shall be conducted with care so that the soldering is uniform and free of defects such as heat shock.																													
		(Unit in mm) <table border="1" style="display: inline-table; margin: 10px;"> <thead> <tr> <th>Size</th> <th>a</th> <th>b</th> <th>C</th> </tr> </thead> <tbody> <tr> <td>0603</td> <td>0.3</td> <td>0.9</td> <td>0.3</td> </tr> <tr> <td>1005</td> <td>0.4</td> <td>1.5</td> <td>0.5</td> </tr> <tr> <td>1608</td> <td>1.0</td> <td>3.0</td> <td>1.2</td> </tr> <tr> <td>2012</td> <td>1.2</td> <td>4.0</td> <td>1.65</td> </tr> <tr> <td>3216</td> <td>2.2</td> <td>5.0</td> <td>2.0</td> </tr> <tr> <td>4520</td> <td>3.5</td> <td>7.0</td> <td>2.5</td> </tr> <tr> <td>4532</td> <td>3.5</td> <td>7.0</td> <td>3.7</td> </tr> </tbody> </table>		Size	a	b	C	0603	0.3	0.9	0.3	1005	0.4	1.5	0.5	1608	1.0	3.0	1.2	2012	1.2	4.0	1.65	3216	2.2	5.0	2.0	4520	3.5	7.0	2.5	4532	3.5
Size	a	b	C																														
0603	0.3	0.9	0.3																														
1005	0.4	1.5	0.5																														
1608	1.0	3.0	1.2																														
2012	1.2	4.0	1.65																														
3216	2.2	5.0	2.0																														
4520	3.5	7.0	2.5																														
4532	3.5	7.0	3.7																														
12	Solderability of Termination (Mounting)	90% of the terminations are to be soldered evenly and continuously. (The capacitors may be mounted on printed-circuit boards or ceramic substrates and no visible damage)		Immerse the test capacitor into a methanol solution containing rosin for 3 to 5 seconds, preheat it 150 to 180°C for 2 to 3 minutes and immerse it into SAC305(Sn96.5Ag3.0Cu0.5) solder of 245 ± 5°C for 3±1seconds. (IEC 60384- 21/22)																													
13	Resistance to Soldering Heat	Appearance	No marking defects	*Preheat the capacitor at 120 to 150°C for 1 minute.																													
		Cap. Change	NP0/X8G within ±2.5% or 0.25pF (whichever is larger)	X5R/X7R/X7S within ±7.5%	Immerse the capacitor in a SAC305(Sn96.5Ag3.0Cu0.5) solder solution at 270±5°C for 10±1 seconds. Let sit at room temperature for 24±2 hours, then measure.																												
		Q/D.F.	If C ≤ 30pF, DF ≤ 1/(400+20C) If C > 30pF, DF ≤ 0.1%	To satisfy the specified initial spec.	* Preheat 150 to 200°C for size ≥ 3216.																												
		I.R.	I.R. ≥ 10,000MΩ or R _C R _R ≥ 100Ω-F. (whichever is smaller)	I.R. ≥ 10,000MΩ or R _C R _R ≥ 100Ω-F. (whichever is smaller)	*High dielectric constant type: Initial measurement : perform a heat treatment at 150+0/-10°C for one hour and then let sit for 24±2 hours at room temperature. Perform the initial measurement.																												

No	Item	Specification		Test Method	
		Temp. compensation type	High dielectric constant type		
14	Temperature cycle (Thermal shock)	Appearance	No marking defects		Solder the capacitor to supporting jig (Glass epoxy board) and perform the five cycles according to the four heat treatments listed in the following table. Let sit for 24±2hrs at room temperature, then measure. Step 1: Minimum operating temperature 30±3min Step 2: Room temperature 2~3 min Step 3: Maximum operating temperature 30±3min Step 4: Room temperature 2~3min *High dielectric constant type: Initial measurement: perform a heat treatment at 150±10°C for one hour and then let sit for 24±2 hours at room temp. Perform the initial measurement. (IEC 60384- 21/22)
		Cap. Change	NPO/X8G within ±2.5% or 0.25pF (whichever is larger)	X5R/X7R/X7S within ±7.5%	
		Q/D.F.	If C ≤ 30pF, DF ≤ 1/(400+20C) If C > 30pF, DF ≤ 0.1%	To satisfy the specified initial spec.	
		I.R.	I.R. ≥ 10,000MΩ or R _C R ≥ 100Ω-F. (whichever is smaller)	I.R. ≥ 10,000MΩ or R _C R ≥ 100Ω-F. (whichever is smaller)	
15	Humidity load	Appearance	No marking defects		Apply the rated voltage (Max. 500V) at 40±2°C and 90 to 95% humidity for 500±12 hours. The charge / discharge current is less than 50mA. [Temperature compensation type] Remove and let sit for 24±2 hours at room temperature, then measure. [High dielectric constant type] *Initial measurement Perform a heat treatment at 150+0/-10°C for one hour and then let sit for 24±2 hours at room temperature. Perform the initial measurement. *Measurement after test Perform a9 heat treatment and then let sit for 24±2 hours at room temperature, then measure.
		Cap. Change	NPO/X8G within ±7.5% or 0.75pF (whichever is larger)	X5R/X7R/X7S within ±12.5%	
		Q/D.F.	If C > 30pF, DF ≤ 0.5% If C ≤ 30pF, DF ≤ 1/(100+10xC/3) C in pF	X5RX7R/X7S 200% max of initial spec.	
		I.R.	I.R. ≥ 500MΩ or R _C R ≥ 25Ω-F. (whichever is smaller)	I.R. ≥ 500MΩ or R _C R ≥ 25Ω-F. (whichever is smaller)	
16	High temperature load life test	Appearance	No marking defects		Apply 150%(120% for ≥ 250V; 100% for ≥ 1000V) of the rated voltage for 1000±12 hours at the maximum operating temperature ± 3°C. The charge / discharge current is less than 50mA. *C3216NP0104JHPSL apply in 100% of the rated voltage for this test. [Temperature compensation type] Remove and let sit for 24±2 hours at room temperature, then measure. [High dielectric constant type] *Initial measurement Perform a heat treatment at 150+0/-10°C for one hour and then let sit for 24±2 hours at room temperature. Perform the initial measurement. *Measurement after test Perform a heat treatment and then let sit for 24±2 hours at room temperature, then measure. * Some of the parts are applicable in rated voltage *100%. Please refer to "Part Number & Characteristic" with (II)* labeled in "Test Spec." (IEC 60384- 21/22)
		Cap. Change	NPO/X8G within ±7.5% or 0.75pF (whichever is larger)	X5R/X7R/X7S within ±12.5%	
		Q/D.F.	If C > 30pF, DF ≤ 0.3% If 10pF < C ≤ 30pF, DF ≤ 1/(275+5xC/2) If C ≤ 10pF, DF ≤ 1/(200+10C), C in pF	X5R/X7R/X7S 200% max of initial spec.	
		I.R.	More than 1GΩ or R _C R ≥ 50Ω-F (whichever is less.)	More than 1GΩ or R _C R ≥ 50Ω-F (whichever is less.)	

Package

- Tape and reel packaging**

Tape and reel packaging is currently the most promising system for high-speed production. A typical 180mm (7 inch) diameter reel contains 1,500 to 15,000 capacitors, 250mm (10 inch) contains 10,000 capacitors, and 330mm (13 inch) contains 10,000 to 50,000 capacitors. Three standard sizes are available in taped and reeled package either with paper carrier tapes or embossed tapes.

【Paper tape specifications】

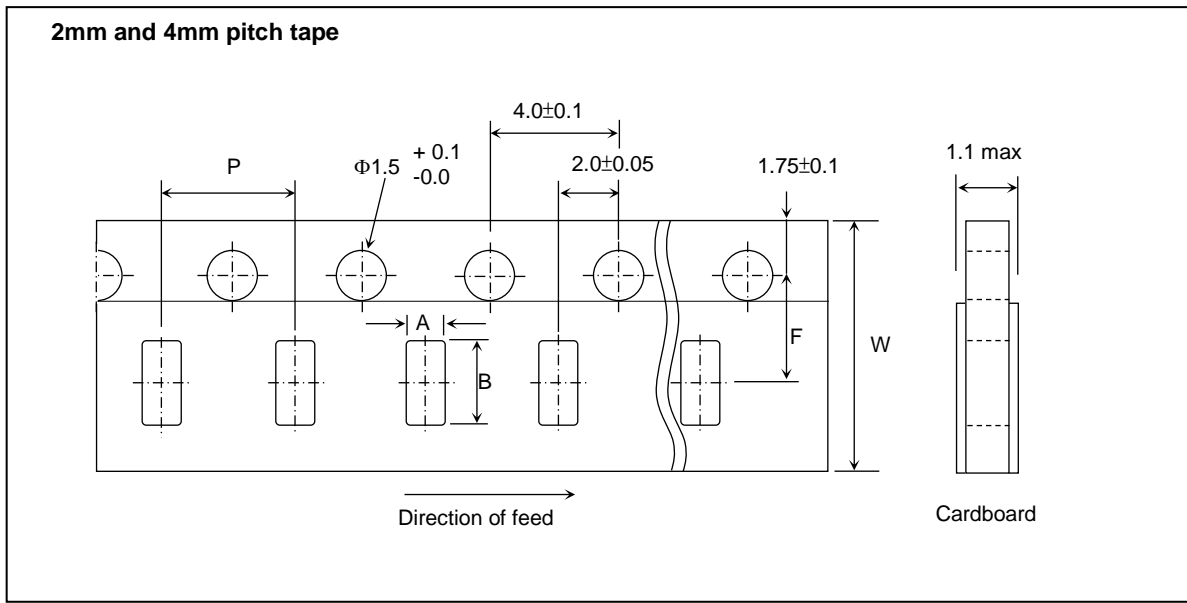

SYMBOL	PRODUCT SIZE CODE										UNIT
	C0603(0201)		C1005(0402) Dim. Tol. : ± 0.05		C1005(0402) Dim. Tol. : ± 0.10		C1005(0402) Dim. Tol. : ± 0.15		C1005(0402) Dim. Tol. : ± 0.20		
	SIZE	TOL.	SIZE	TOL.	SIZE	TOL.	SIZE	TOL.	SIZE	TOL.	
A	0.38	± 0.04	0.65	± 0.10	0.70	± 0.10	0.72	± 0.10	0.80	± 0.10	mm
B	0.68	± 0.04	1.15	± 0.10	1.19	± 0.10	1.25	± 0.10	1.35	± 0.10	mm
F	3.5	± 0.05	3.5	± 0.05	3.5	± 0.05	3.5	± 0.05	3.5	± 0.05	mm
P	2	± 0.10	2	± 0.10	2	± 0.10	2	± 0.10	2	± 0.10	mm
W	8	± 0.20	8	± 0.20	8	± 0.20	8	± 0.20	8	± 0.20	mm

SYMBOL	PRODUCT SIZE CODE								UNIT
	C1608(0603) Dim. Tol. : ± 0.10/± 0.15		C1608 (0603) Dim. Tol. : ± 0.20/± 0.25		C2012 (0805)		C3216 (1206)		
	SIZE	TOL.	SIZE	TOL.	SIZE	TOL.	SIZE	TOL.	
A	1.0	±0.2	1.1	±0.2	1.5	±0.2	1.9	±0.2	mm
B	1.8	±0.2	1.9	±0.2	2.3	±0.2	3.6	±0.2	mm
F	3.5	±0.05	3.5	±0.05	3.5	±0.05	3.5	±0.05	mm
P	4	±0.1	4	±0.1	4	±0.1	4	±0.1	mm
W	8	±0.2	8	±0.2	8	±0.2	8	±0.2	mm

【 Embossed tape specifications 】

1mm and 4mm and 8mm pitch tape

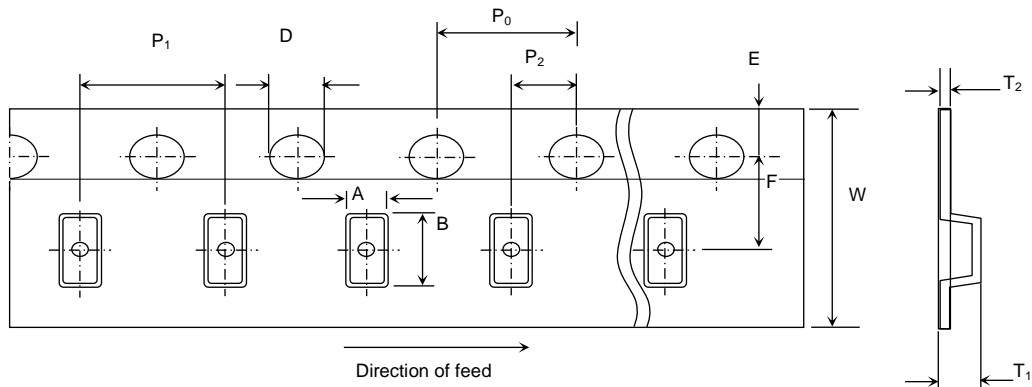

DIMENSION (mm)	PRODUCT SIZE CODE					
	1608 (0603)	2012 (0805)	3216 (1206)	3225 (1210)	4520 (1808)	4532 (1812)
P_1	4 ± 0.1	4 ± 0.1	4 ± 0.1	4 ± 0.1	4 ± 0.1	8 ± 0.1
P_0	4 ± 0.1	4 ± 0.1	4 ± 0.1	4 ± 0.1	4 ± 0.1	4 ± 0.1
P_2	2 ± 0.05	2 ± 0.05	2 ± 0.05	2 ± 0.05	2 ± 0.05	2 ± 0.05
A	1.2 ± 0.2	1.45 ± 0.2	1.9 ± 0.2	2.8 ± 0.2	2.3 ± 0.2	3.6 ± 0.2
B	2.0 ± 0.2	2.3 ± 0.2	3.5 ± 0.2	3.6 ± 0.2	4.9 ± 0.2	4.9 ± 0.2
W	8 ± 0.3	8 ± 0.2	8 ± 0.2	8 ± 0.2	12 ± 0.2	12 ± 0.2
E	1.75 ± 0.1	1.75 ± 0.1	1.75 ± 0.1	1.75 ± 0.1	1.75 ± 0.1	1.75 ± 0.1
F	3.5 ± 0.05	3.5 ± 0.05	3.5 ± 0.05	3.5 ± 0.05	5.5 ± 0.05	5.5 ± 0.05
D	1.5 (+0.1/-0.0)	1.5 (+0.1/-0.0)	1.5 (+0.1/-0.0)	1.5 (+0.1/-0.0)	1.5 (+0.1/-0.0)	1.5 (+0.1/-0.0)
T_1	1.4 max.	2.0 max.	2.2 max.	3.0 max.	2.5 max.	4.5 max.
T_2	0.25 ± 0.1	0.30 ± 0.1	0.30 ± 0.1	0.30 ± 0.1	0.30 ± 0.1	0.30 ± 0.1

【Reel specifications】

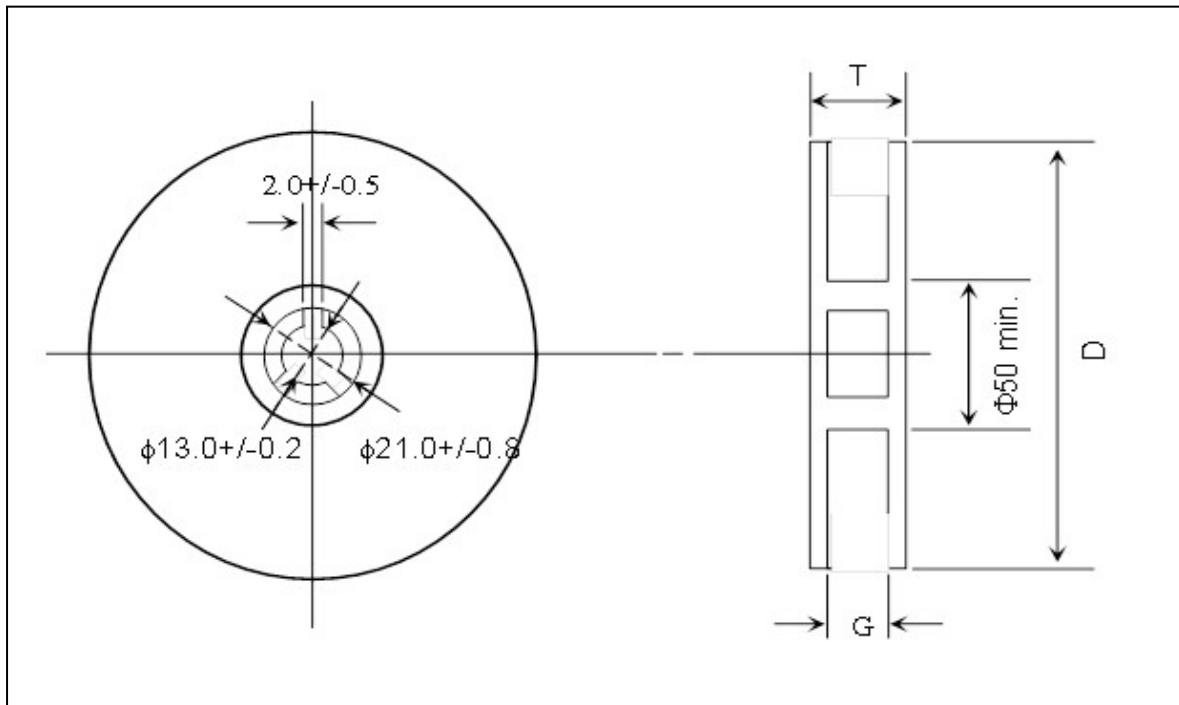

TAPE WIDTH (mm)	G (mm)	T max. (mm)	D (mm)
4	5.0 ± 1.5	8.0	180
8	10.0 ± 1.5	14.5	180
8	10.0 ± 1.5	14.5	250
8	10.0 ± 1.5	14.5	330
12	14.0 ± 1.5	18.5	180

MLCC

【Thickness and Packing Amount】

Thickness			Amount per reel			
Code	Spec.(mm)	Size (EIA)	180 mm (7")		330 mm (13")	
			Paper	Embossed	Paper	Embossed
Z	0.20	0402 (01005)	20K	40K ^{#1}		
A	0.30	0603 (0201)	15K		50K	
		1005 (0402)	15K		50K	
B	0.50	1005 (0402)	10K		50K	
Q	0.45	1005 (0402)	10K		50K	
		1608 (0603)	4K		15K	
C	0.60	2012 (0805)	4K		15K	
		3216 (1206)	4K		15K	
D	0.80	1608 (0603)	4K	4K	15K	
E	0.85	2012 (0805)	4K		15K	
		3216 (1206)	4K		15K	
		3225 (1210)		3K		10K
I	0.95	4532 (1812)		1K		
		2012 (0805)		3K		
F	1.15	3216 (1206)		3K		
		4520 (1808)		3K		10K
G	1.25	3216 (1206)		3K		10K
		2012 (0805)		2K/3K		10K
		3225 (1210)		3K		10K
		4520 (1808)		3K		
		4532 (1812)		2K/3K		
		3225 (1210)		1K		
L	1.60	3216 (1206)		2K		
		3225 (1210)		2K		
		4520 (1808)		2K		
		4532 (1812)		1K		
N	2.00	3216 (1206)		2K/3K		
		3225 (1210)		2K		
		4520 (1808)		1K/2K		
		4532 (1812)		1K		
P	2.50	3225 (1210)		500pcs/1K		
		4532 (1812)		500pcs		

#1: 4mm width 1mm pitch Embossed Taping

【Packing Rule】

EIA SIZE	Tape type	Reel Size	Max Reels/Box
0402 (01005)	Emboss	7"	16
0402 (01005)	Paper	7"	10
0603 (0201)	Paper	7"	10
1005 (0402)	Paper	7"	10
1608 (0603)	Paper/Emboss	7"	10
2012 (0805)	Paper/Emboss	7"	10
3216 (1206)	Paper/Emboss	7"	10
3225 (1210)	Emboss	7"	10
4520 (1808)	Emboss	7"	10
4532 (1812)	Emboss	7"	10

*Maximum 60 reels in one carton.

Others

【Storage】

1. The chip capacitors shall be packaged in carrier tapes or bulk cases.
2. Too high temperatures or humidity may deteriorate the quality of the product rapidly. Recommended products storage with temperatures from +5°C to +35°C, humidity from 45 to 70% RH.
3. The storage atmosphere must be free of gas containing sulfur and chlorine. Also, avoid exposing the product to saline moisture. If the product is exposed to such atmospheres, the terminations will oxidize and solderability will be affected.
4. In consideration of solderability, an allowable storage period should be within 12 months from the outgoing date of delivery. As for products in storage over 12 months, please check solderability before use.

【Circuit Design】

1. Once application and assembly environments have been checked, the capacitor may be used in conformance with the rating and performance, which are provided in both the catalog and the specifications. Exceeding the specifications listed may result in inferior performance. It may also cause a short, open, smoking, or flaming to occur, etc.
2. Please use the capacitors in conformance with the operating temperature provided in both the catalog and the specifications. Be especially cautious not to exceed the maximum temperature. In the situation the maximum temperature set forth in both the catalog and specifications is exceeded, the capacitor's insulation resistance may deteriorate, power may suddenly surge and short-circuit may occur. The loss of capacitance will occur, and may self-heat due to equivalent series resistance when alternating electric current is passed through. As this effect becomes critical in high frequency circuits, please exercise with caution. When using the capacitor in a (self-heating) circuit, please make sure the surface of the capacitor remains under the maximum temperature for usage. Also, please make certain temperature rise remain below 20°C.
3. Please keep voltage under the rated voltage, which is applied to the capacitor. Also, please make certain the peak voltage remains below the rated voltage when AC voltage is super-imposed to the DC voltage. In the situation where AC or pulse voltage is employed, ensure average peak voltage does not exceed the rated voltage. Exceeding the rated voltage provided in both catalog and specifications may lead to defective withstanding voltage or, in worse case situations, may cause the capacitor to burn out.
4. It's is a common phenomenon of high-dielectric products to have a deteriorated amount of static electricity due to the application of DC voltage.

【Handling】

Chip capacitors should be handled with care to avoid contamination or damage. The use of vacuum pick-up or plastic tweezers is recommended for manual placement. Tape and reeled packages are suitable for automatic pick and placement machine.

【Flux】

1. An excessive amount of flux or too rapid temperature rise can causes solvent burst, solder can generate a large quantity of gas. The gas can spreads small solder particles to cause solder balling effect or bridging problem.
2. Flux containing too high of a percentage of halide may cause corrosion of termination unless sufficient cleaning is applied.
3. Use rosin-type flux. Highly acidic flux (halide content less than 0.2wt%) is not recommended.
4. The water soluble flux causes deteriorated insulation resistance between outer terminations unless sufficiently cleaned.

【Component Spacing】

For wave soldering components, the spacing must be sufficient far apart to prevent bridging or shadowing. This is not so important for reflow process but enough space for rework should be considered. The suggested spacing for reflow soldering and wave soldering is 0.5mm and 1.0mm, respectively.

【Solder Fillet】

Too much solder amount may increase solder stress and cause crack risk. Insufficient solder amount may reduce adhesive Strength and cause parts falling off PCB. When soldering, confirm that the solder is placed over 0.2mm of the surface of the terminations.

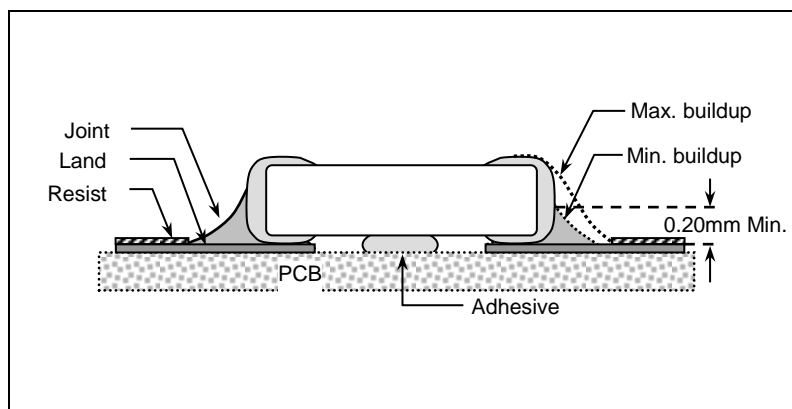

【Recommended Land Pattern Dimensions】

When mounting the capacitor to substrate, it's important to consider that the amount of solder (size of fillet) used has a direct effect upon the capacitor once it's mounted.

1. The greater the amount of solder, the greater the stress to the elements, as this may cause the substrate to break or crack.
2. In the situation where two or more devices are mounted onto a common land, separate the device into exclusive pads by using soldering resist.
3. Land width equal to or less than component. It is permissible to reduce land width to 80% of component width.

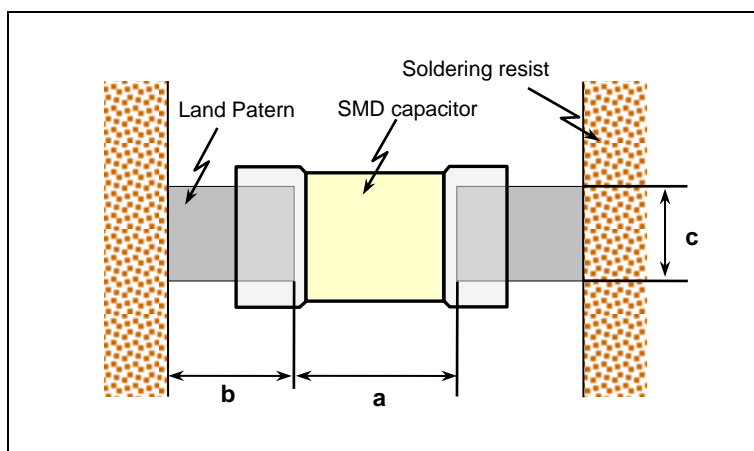

Size mm (EIA)	L x W (mm) (Dimension tolerance)	a (mm)	b (mm)	c (mm)
0402 (01005)	0.4*0.2	0.16 to 0.20	0.12 to 0.18	0.20 to 0.23
0603 (0201)	0.6*0.3 (within±0.03)	0.2 to 0.35	0.2 to 0.3	0.2 to 0.4
	0.6*0.3 (±0.05/±0.09)	0.2 to 0.35	0.2 to 0.35	0.25 to 0.4
1005 (0402)	1.0*0.5 (within±0.10)	0.3 to 0.5	0.35 to 0.45	0.4 to 0.6
	1.0*0.5 (±0.15/±0.20)	0.4 to 0.6	0.4 to 0.5	0.5 to 0.7
1608 (0603)	1.6*0.8 (within±0.10)	0.7 to 1.0	0.6 to 0.8	0.7 to 0.8
	1.6*0.8 (±0.15/±0.20/±0.25)	0.8 to 1.1	0.7 to 0.8	0.8 to 1.0
2012 (0805)	2.0*1.25	1.0 to 1.4	0.7 to 0.9	1.2 to 1.4
3216 (1206)	3.2*1.6 (within±0.20)	1.8 to 2.4	0.9 to 1.2	1.5 to 1.9
	3.2*1.6 (within±0.30)	1.9 to 2.5	1.0 to 1.3	1.7 to 2.0
3225 (1210)	3.2*2.5	1.8 to 2.5	1.0 to 1.2	2.0 to 2.5
4520 (1808)	4.5*2.0	3.2 to 3.8	1.2 to 1.4	1.7 to 2.0
4532 (1812)	4.5*3.2	3.0 to 3.5	1.4 to 1.6	2.7 to 3.5

【Resin Mold】

If a large amount of resin is used for molding the chip, cracks may occur due to contraction stress during curing. To avoid such cracks, use a low shrinkage resin. The insulation resistance of the chip will degrade due to moisture absorption. Use a low moisture absorption resin. Check carefully that the resin does not generate a decomposition gas or reaction gas during the curing process or during normal storage. Such gases may crack the chip capacitor or damage the device itself.

【Soldering Profile for SMT Process with SnPb Solder Paste】

Reflow Soldering

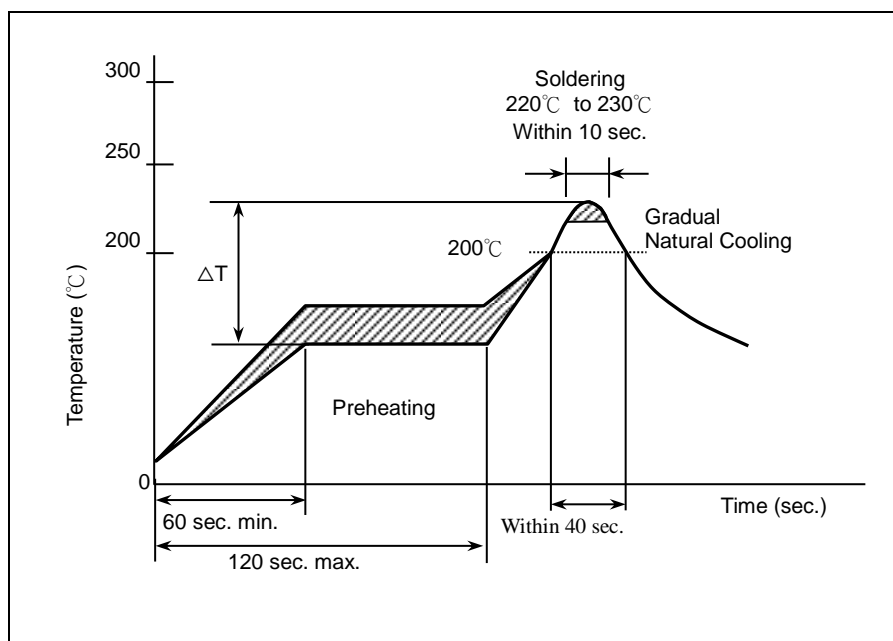

The difference between solder and chip surface should be controlled as following table. The rate of preheat should not exceed 4°C/sec and a target of 2°C/sec is preferred.

Chip Size	3216 and smaller	3225 and above
Preheating	$\Delta T \leq 150^\circ\text{C}$	$\Delta T \leq 130^\circ\text{C}$

Wave Soldering

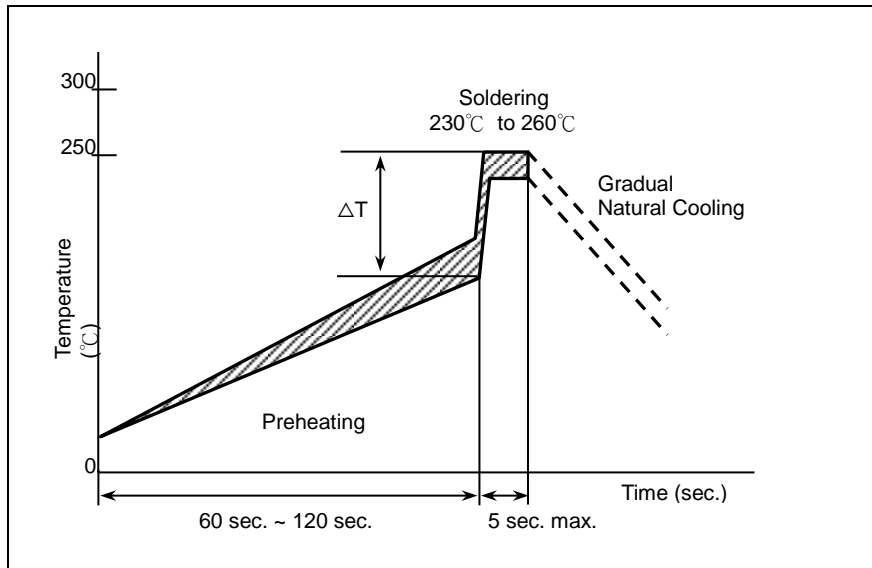

Chip Size	1608/2012/3216	3225 and above
Preheating	$\Delta T \leq 150^\circ\text{C}$	-

Soldering Iron

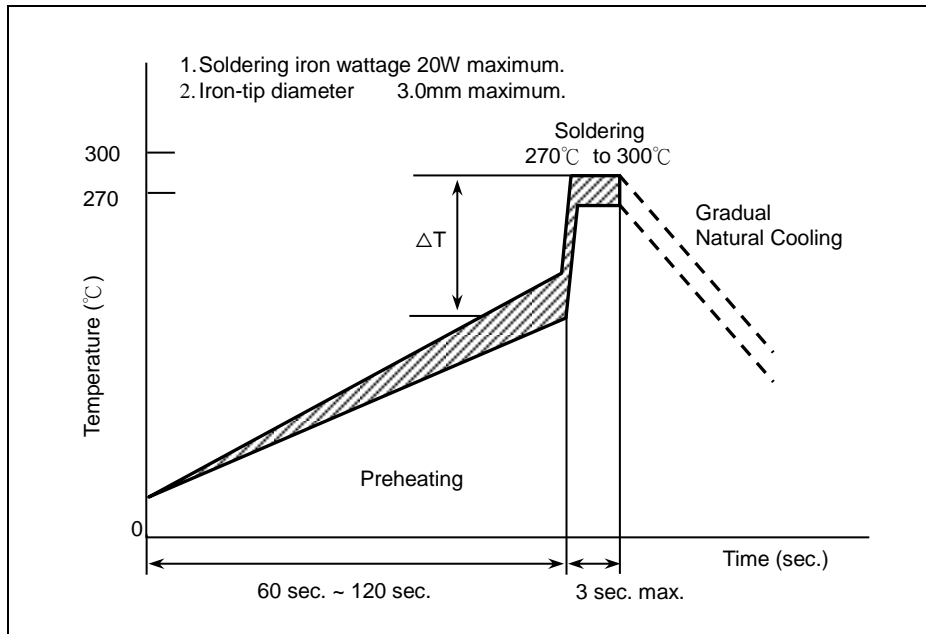

Chip Size	3216 and smaller	3225 and above
Preheating	$\Delta T \leq 190^\circ\text{C}$	$\Delta T \leq 130^\circ\text{C}$

MLCC

【Soldering】

Reflow Soldering for Lead free Termination

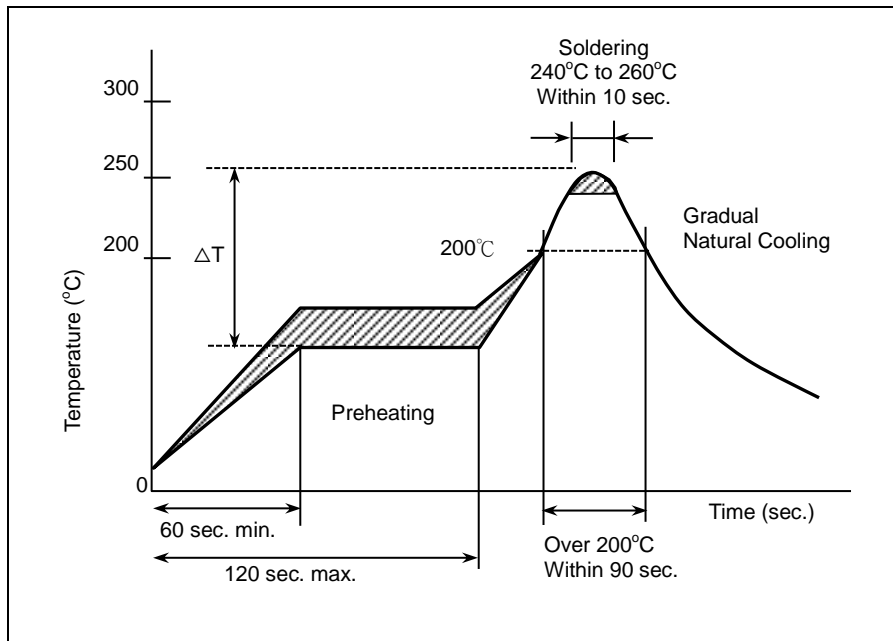

The difference between solder and chip surface should be controlled as following table. The rate of preheat should not exceed 4°C/sec and a target of 2°C/sec is preferred.

Chip Size	3216 and smaller	3225 and above
Preheating	$\Delta T \leq 150^\circ\text{C}$	$\Delta T \leq 130^\circ\text{C}$

Wave Soldering for Lead free Termination

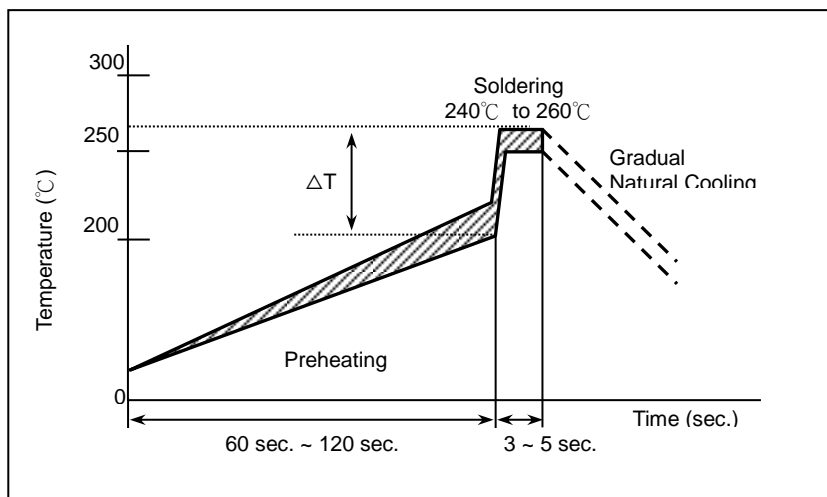

Chip Size	1608/2012/3216	3225 and above
Preheating	$\Delta T \leq 150^\circ\text{C}$	-

Soldering Iron

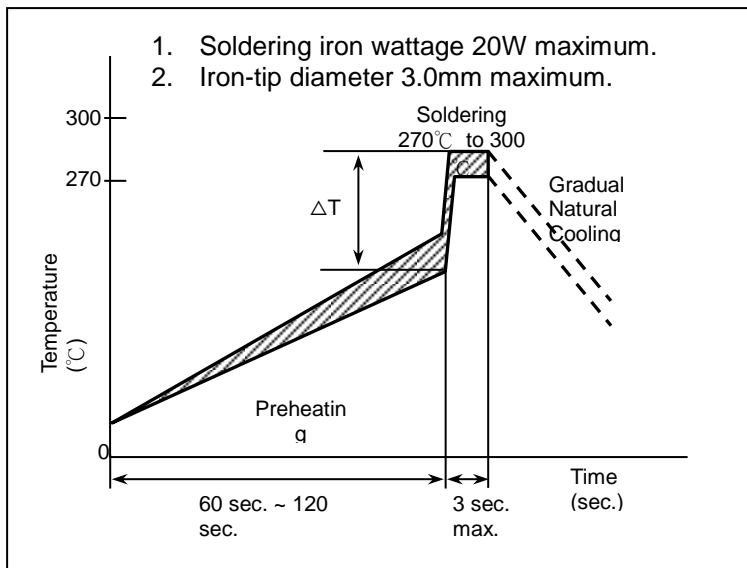

Chip Size	3216 and smaller	3225 and above
Preheating	$\Delta T \leq 190^{\circ}\text{C}$	$\Delta T \leq 130^{\circ}\text{C}$

【Chip Layout and Breaking PCB】

- To layout the SMD capacitors for reducing bend stress from board deflection of PCB. The following are examples of Hood and bad layout.

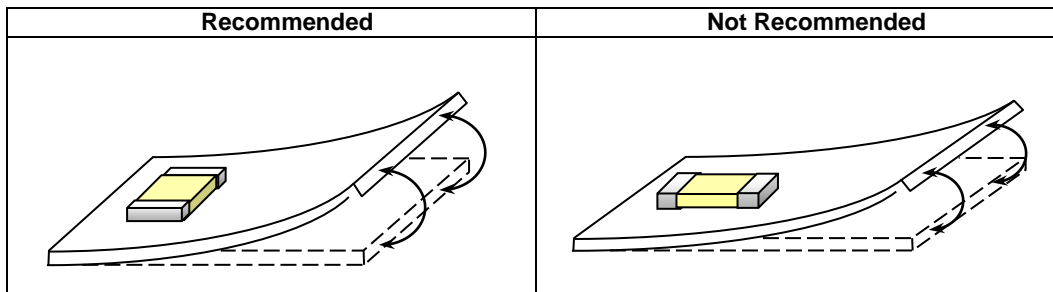

- When breaking PCB, the layout should be noted that the mechanical stresses are depending on the position of capacitors. The following example shows recommendation for better design.

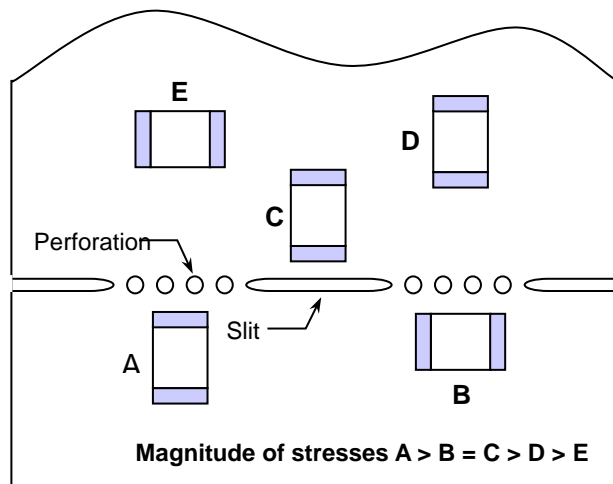

【Aging Rate】

The capacitance and dissipation factor of class 2 capacitors decreases with time. It is known as ‘aging’ that follows a logarithmic law and expressed in terms of an aging constant. Aging is caused by a gradual re-alignment of the crystalline structure of the ceramic. The aging constant is defined as the percentage loss of capacitance at a ‘time decade’. The law of capacitance aging is expressed as following equation:

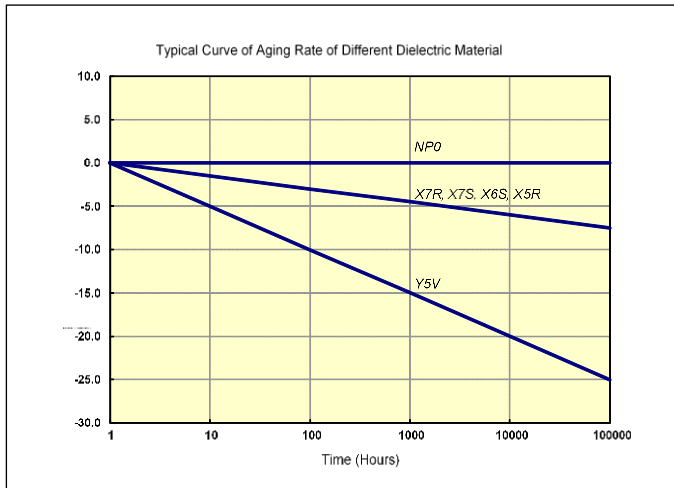

$$C_{t2} = C_{t1} \times (1 - k \times \log_{10}(t_2/t_1))$$

C_{t1} : Capacitance after t_1 hours of start aging.

C_{t2} : Capacitance after t_2 hours of start aging.

k : aging constant (capacitance decrease per decade)

t_1, t_2 : time in hours from start of aging.

A typical curve of aging rate is shown in following figure.

When heating the capacitors above Curie temperature (130°C~150°C) the capacitance can be re-new. So capacitance of class 2 capacitors will be complete de-aged by soldering process; subsequently a new aging process begins.

Because of aging, it is specified an age for measurement to meet the prescribed tolerance for class 2 capacitors. Normally, 1000 hours ($t_2=1000$ hrs) is defined.

【Peeling Off Force】

Peeling off force: 0.1N to 1.0 N* in the direction shown as below.

The peeling speed: 300±10 mm/min

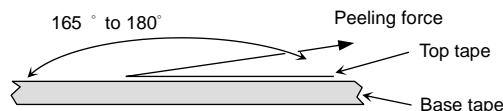

1. The taped tape on reel is wound clockwise. The sprocket holes are to the right as the tape is pulled toward the user.
2. There are minimum 150 mm as the leader and minimum 40 mm empty tape as the tail is attached to the end of the tape.